

ISDA[®]

Safe,
Efficient
Markets

Unique Trade Identifier (UTI): Generation, Communication and Matching

As of 2015 March 20

www.isda.org

Contents

1	Document Scope and Objectives	4
2	Unique Trade Identifier (UTI) – Key Principles	4
3	Usage of UTI as the Standard for Trade Identifiers	5
3.1	Summary	5
4	Unique Trade Identifier (UTI) Construct	6
4.1	Background summary	6
4.2	Construct	6
4.3	UTI Prefix Waterfall	7
4.4	UTI Prefix Fallback	8
5	Generic Trade Workflows	8
5.1	Electronic Execution	9
5.1.1	Electronic Execution – No Allocation	9
5.1.2	Electronic Execution – Allocated	10
5.2	Broker/Direct Submission to Middleware	10
5.2.1	Affirm in Middleware	10
5.2.2	Confirm Matched in Middleware	11
5.2.3	Paper Trades	12
5.2.4	Affirm in Middleware – Cleared trade example (extension of scenario 4.2.1)	13
5.3	Cleared Trades	14
5.3.1	Unlinked Principal Trades	14
5.3.2	Unlinked Agency Trades	18
5.3.3	Linked Trades	20
5.4	Novations	22
5.4.1	Novated over Middleware	22
5.4.2	Novation on Paper	22
5.5	Prime Brokerage Flows	23

5.5.1	With Middleware	23
5.5.2	No Middleware	24
5.5.3	(a) Allocation(s) with preceding Block Trade	25
5.5.3	(b) Allocation(s) with no preceding Block Trade	26
5.5.4	(a) Novation when original trade has cleared	27
5.5.4	(b) Novation when original trade has not cleared	28
5.5.5	(a) Unwind when original trade has cleared	29
5.5.5	(b) Unwind when original trade has not cleared	29
5.5.6	PB executes full compression for Client per Client request	30
5.5.7	Intermediations	31
5.5.8	Negative Affirmation: Prime Equity Synthetics Front-to-Back Workflow	32
6	UTI Generation and Matching for Historical Trade Populations	33
6.1	Summary	33
6.2	Principles	33
7	Appendices	34
7.1	Creation of UTI - Event Table	34
7.2	UTI Generator - Decision Tree	35
7.3	Determination of the UTI Generating Party	36
8	Glossary	39
8.1	Acronyms used	39

Any updates to this document will be posted on the [ISDA Data, Reporting and FpML](#) website.

1 Document Scope and Objectives

Derivatives reporting regulations promulgated by various global regulators contain a requirement to use a Unique Trade Identifier (UTI) for transactional reporting. But despite use of the same or similar terminology (Unique Transaction Identifier, Unique Trade Identifier, Unique Swap Identifier) and purpose (an identifier unique to the transaction known to and used by all relevant parties), no global regulatory standard for UTI was developed, agreed or endorsed universally by regulators in advance of the commencement of transaction reporting. Instead transaction reporting regulations are either silent on the requirements for a UTI, allow use of an industry standard or trade repository identifiers, or else prescribe a regulator specific method for creation of a UTI that precludes its use in other jurisdictions and does not facilitate global data aggregation and analysis.

Anticipating the need for a globally consistent approach to creation and use of UTI for multi-jurisdictional transaction reporting, ISDA worked with market participants to develop the standards in this document that address the creation and exchange of a single UTI for global reporting. Although broadly in use by the industry, consistent use of a this, or any, global UTI standard cannot be fully achieved without the participation of all market participants with transaction reporting obligations and the endorsement or requirement of such standard by regulators to incentivize its universal application. To that end, ISDA will continue to work with global regulators on adoption of a universal standard, while still enhancing and maintaining the standard provided in this document for the mutual benefit of market participants and regulators.

This document focuses primarily on OTC flows. ETD transactions are addressed by the FIA, and this paper will seek to align with those where possible.

NOTE: This is intended to be a living document, thus is subject to change in accordance with the discussions and views of the industry participants and evolving trading standards and practices. As such, parties should refer to the latest version of the document.

2 Unique Trade Identifier (UTI) – Key Principles

The following principles were captured during workshops in relation to the generation, communication and matching of the UTI.

- 1 This paper outlines best practices to be followed by market participants, unless otherwise negotiated between Parties. Note that the best practice UTI construct outlined in this whitepaper is not subject to bilateral negotiation.
- 2 All trades should have a Unique Trade Identifier (UTI) which is generated, communicated and, for historical trade populations, matched.¹
- 3 If a trade requires a Unique Swap Identifier (USI), this should be used as the UTI.

¹ See §5 "Notes Applicable to Workflows" for additional information.

- 4 UTI generation and communication should occur at the earliest possible point in the trade flow. The list below is ordered in preference:
 - Centrally executed trades – reference is generated and communicated at the point of execution on a platform that can generate a UTI and ensure its uniqueness.
 - Up-front affirmed – reference is generated and communicated at the point of submission to an affirmation platform or service.
 - Electronic confirmation matched (post-trade) – reference is generated at submission and communicated at point of confirmation.
 - Paper trades – unless otherwise communicated, a reference is generated by individual firms who share via paper and update their reporting to reference the UTI for the trade once agreed by counterparties.
- 5 To communicate the UTI, if electronic means are available, Parties should communicate the UTI using the affirmation or matching platform. If no electronic means are available, then Parties should first look to communicate the UTI through trade recap via email or voice, and if this is not possible, then through intraday or EOD reconciliation reporting. Otherwise, communicate via exchange of the paper confirm, if applicable. In instances where there is an electronic trade affirmation process (email, xls, csv, etc), Parties should agree the UTI electronically as part of this trade affirmation process. For the avoidance of doubt, the best practice of affirming the UTI and UTI Generating Party via this affirmation process does not replace the need to exchange the UTI on the confirmation.
- 6 Determination of who defines the UTI for paper trades should follow existing industry best practices for that asset class. Further detail for each asset class is available in Appendix 7.3 “Determination of the UTI Generating Party.” For trades where the UTI Generating Party (GP) is unclear, the Parties can agree bilaterally on who will be the UTI GP.
- 7 In general for Prime Brokerage, the ED is the UTI generator for the ED/PB leg, while the PB is the UTI generator for the Client/PB leg.

3 Usage of UTI as the Standard for Trade Identifiers

3.1 Summary

Although the development of a unique trade identifier was initiated with the Unique Swap Identifier (USI), since CFTC reporting came into realization before other jurisdictions, the UTI is the primary value for global reporting, with the USI in reality a subset of the UTI. The industry is committed to utilization of a single unique identifier to report transactions, even as reporting expands globally. This approach promotes efficiency and consistency, and facilitates global aggregation and reconciliation of trade repository data. As such, "Unique Trade Identifier (UTI): Generation, Communication, and Matching" would be the prevailing document for Parties to refer to with regards to unique trade identifiers. "Unique Swap

Identifier (USI): An Overview Document"² would be referred to by Parties who have an obligation to report to CFTC.

As such, the industry best practice which parties should follow is use of the UTI as the primary Trade Identifier in global regulatory reporting. In cases where one of the parties has a reporting obligation to the CFTC or is a CFTC registrant, the UTI may align with the technical standard established by the CFTC for USI, but that trade identifier value should be considered the UTI for purposes of global regulatory reporting and recordkeeping. In the rare event that a transaction ends up with both a USI and a UTI (e.g. because the trade became reportable to the CFTC after reporting was required to other global regulators, and the UTI wasn't CFTC compliant), the parties should use the UTI for global reporting and reserve the USI solely for reporting to the CFTC.

4 Unique Trade Identifier (UTI) Construct

4.1 Background summary

Industry groups have strived to find a unified solution for the prefix portion of the UTI for non-CFTC registered reporting counterparties. Although the preferred approach was use of the 20 character Legal Entity Identifier (LEI), it emerged during industry discussions that many FX systems were designed to accommodate up to, and including, a 10 character prefix, and could not easily or readily be changed. Industry groups examined many alternatives in order to find a solution which would work across all asset classes, and agreed on the one outlined in this section.

The Global LEI System³ is being used as a foundation for this 10 character UTI prefix solution. Characters 7-18 form the alphanumeric, entity-specific portion of the 20 character global LEI number allocation scheme. The first 10 characters, characters 7-16, of this entity-specific portion should thus be used as the UTI prefix in line with the construct and waterfall described below.

4.2 Construct

In order to ensure uniqueness across all reportable transactions, a Unique Trade Identifier (UTI) is comprised of two parts:

1. a UTI Prefix that is unique to the party generating the UTI; and
2. a Transaction Identifier

Provided the UTI Generating Party (GP) ensures it always issues a new Transaction Identifier in relation to their UTI Prefix, each UTI value in the industry should be unique. In order to ensure each party has a reserved UTI Prefix, the industry has agreed the following approach for each UTI Generating Party to determine their UTI Prefix.

² <http://www2.isda.org/attachment/NDQ1Nw==/USI%20Overview%20Document%20final%20version.pdf>

³ FSB, "Third progress note on the Global LEI Initiative" Annex 2, October 2012. LEI ROC, "Allocation of Pre-LOU Prefixes for Pre-LEI Issuance" 14 June 2013.

Since the USI Namespace is only available to those who register with the CFTC⁴, not all trading counterparties are going to have one. Counterparties should first look to use the CFTC USI Namespace as the UTI prefix. If a Party does not have a CFTC USI Namespace, and needs to generate a UTI for global reporting, use characters 7-16 of the global LEI as the 10 character UTI prefix. The current LEI ROC number allocation scheme allows for the 10 characters to contain numbers (0-9) or capital letters (A-Z).

If a trade is not reportable to the CFTC, but a Party has a USI Namespace, that USI Namespace should still be used.

The Q&A on EMIR reporting issued by ESMA on February 11, 2014⁵ includes guidance on the UTI construct in TR Answer 18. It is our understanding that the methods listed therein for UTI construct are illustrations of methods acceptable for reporting under EMIR but they are not an exclusive list of the methods by which the parties can agree to construct the UTI.

The "UTI Prefix Waterfall" diagram in §4.3 illustrates the hierarchy.

4.3 UTI Prefix Waterfall

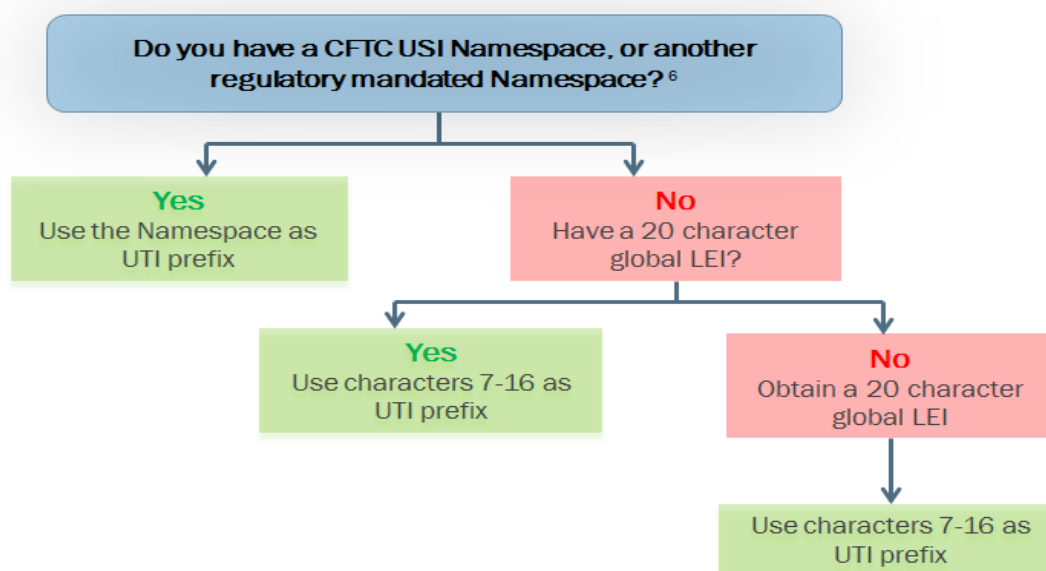

⁴ For CFTC specifications on USI Namespace, refer to "Unique Swap Identifier (USI) Data Standard" 1 October 2012. <http://www.cftc.gov/ucm/groups/public/@swaps/documents/dfs submission/usidatastandards100112.pdf>

⁵ http://www.esma.europa.eu/system/files/2014-164_qa_vi_on_emir_implementation_-_11_february_14.pdf





⁶ For UTI prefix, the European Association of Clearing Houses (EACH) recommends that CCPs use the CFTC Namespace where possible. Where a CCP does not have a CFTC issued Namespace, EACH proposes CCPs use the Market Identifier Code (MIC), a 4 alpha character code (ISO 10383), to create the 10 character "MIC Namespace" UTI prefix by starting with 3 zeros, followed by the MIC code, and then three additional zeros. For example "000CCPU000."

4.4 UTI Prefix Fallback

If a party obtains an LEI from an LOU which is generating sequentially, it is possible that characters 7-16 of the LEI may duplicated across multiple LEI recipients. Currently, this situation exists in limited scope with respect to the LOU Registro Mercantil del Reino de España. ISDA is working with market participants on a solution to use a 10 character UTI prefix algorithmically-derived from the 20 character LEI as a fallback. The UTI whitepaper will be updated to reflect the solution when it is ready for practical application.

5 Generic Trade Workflows

Key

-  UTI Generation and Communication flow
-  Unwind, Step Out, Termination flow
-  Netted flows
-  Reporting (if line is dashed, indicates could be reported by Middleware of Party to trade)
-  Allocation(s)

Notes Applicable to Workflows

If Parties do not have a UTI at time of reporting, they should report using their own trade reference until a UTI is agreed, at which time they update and report with the agreed, final UTI.

Where possible, the exchange of the UTI should be a part of the Novation Consent Process.

The illustrating cases given assume each Party is Principal to the trade unless otherwise specified, and are therefore each party has a regulatory reporting obligation under either the same or different jurisdictions.

5.1 Electronic Execution

5.1.1 Electronic Execution – No Allocation

For any trade executed on an electronic platform, both Parties should use the UTI generated by the electronic platform if available, otherwise, they should default to the next available point of the trade flow for determination, i.e. Middleware or Paper flow (see relevant trade flows).

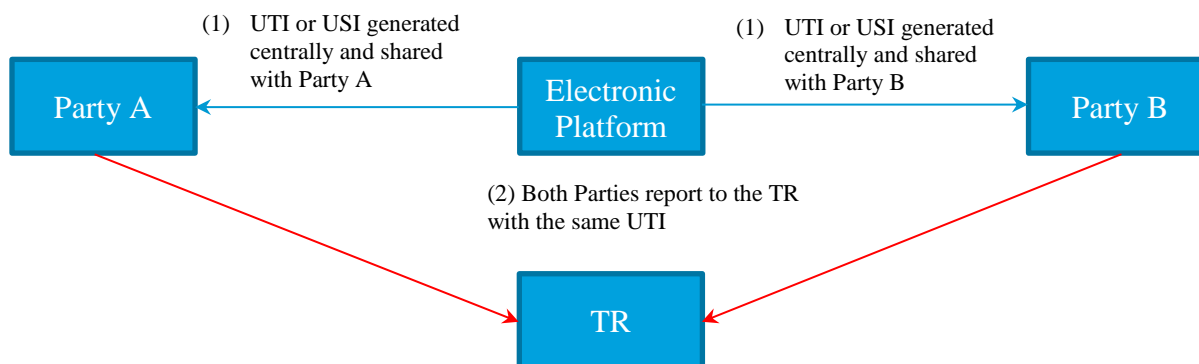

*Note: A broker may, in certain markets, be treated as a platform and be capable of generating a UTI for the Parties. However, brokers should abide by the following in cases where the trade is reportable to the CFTC, the broker is incapable of producing a USI value for use in global reporting, **and** middleware is able to produce a compliant USI:*

Under CFTC reporting requirements, a broker that is registered as a Swap Execution Facility (“SEF”) is required to create a USI using the USI Namespace assigned to it by the CFTC. The SEF’s USI should be used as the UTI for global reporting, in accordance with Key Principle 3.

A broker that is not registered as a SEF is not able to create a CFTC compliant USI since it will not be assigned a USI Namespace. Although a non-SEF broker may be capable of creating a UTI, in cases where the trade is subject to CFTC reporting the Reporting Counterparty or middleware will not be able to use the broker’s UTI as the USI and will be forced to create a separate USI.

In accordance with Key Principle 4, generation of UTI by a central execution platform is the most efficient method for creation and communication of UTI. However, in order to promote creation and use of a single global trade identifier, if a non-SEF broker is unable to determine whether a trade is eligible for CFTC reporting but knows it is submitting the trade to a middleware provider that is capable of (i) making that determination and (ii) generating USI or UTI, as appropriate, then the broker should not create a UTI for the trade. (See 5.2.1 below re: USI/UTI generation via middleware.) For the avoidance of doubt, non-SEF brokers who may be part of a wider corporation which may include a SEF entity should still follow this best practice for trades executed via their non-SEF entities.

5.1.2 Electronic Execution – Allocated

If the trade is allocated over a platform, and the platform (electronic direct allocation) can generate the UTI for each allocation and notify both Parties, then this should be used. The platform over which the trade is allocated may not be the same as that upon which it was executed.

Where a trade is allocated off-platform (or the platform cannot generate a UTI), then the Dealer allocating the trade will generate the UTIs and notify the buy-side of the references via the confirmation process.

5.2 Broker/Direct Submission to Middleware

5.2.1 Affirm in Middleware

There is no central generation of UTI at point of execution. Both Parties agree the trade with a Broker and the Broker inputs to Middleware or, the trade is agreed bilaterally and input by one side into Middleware.

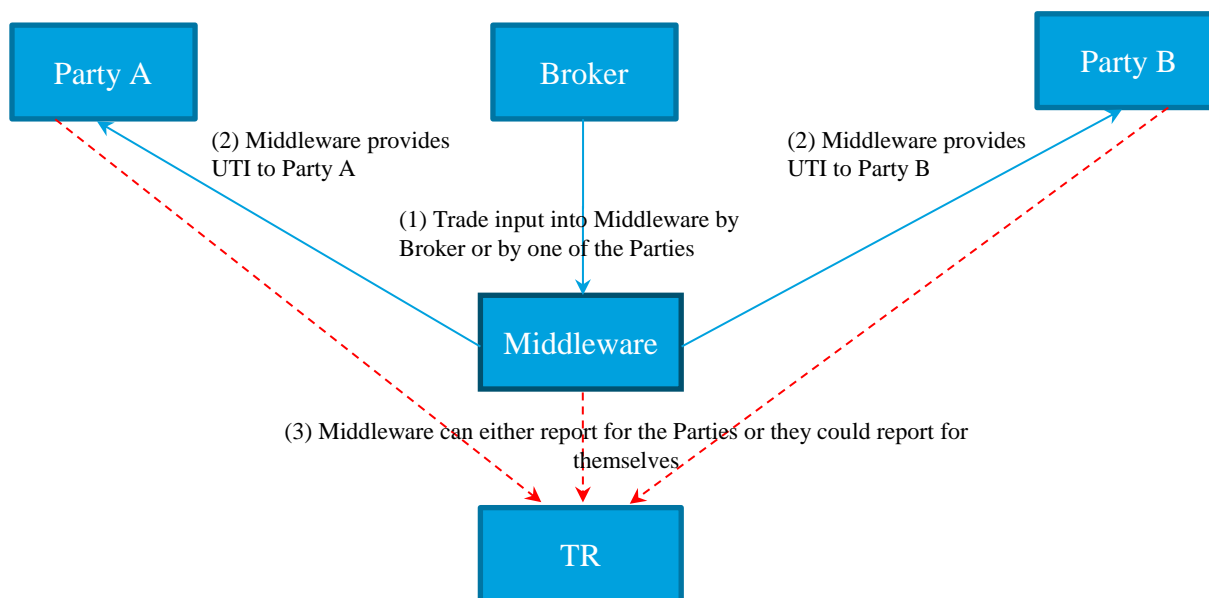

Both Parties affirm trade in the Middleware system. Middleware system will generate a UTI which will be shared and consumed by both Parties to the trade.

5.2.2 Confirm Matched in Middleware

There is no central generation of UTI at point of execution. The trade is either done by a Broker, or bilaterally agreed between Counterparties. Trade details are sent to Middleware by Parties A and B for matching.

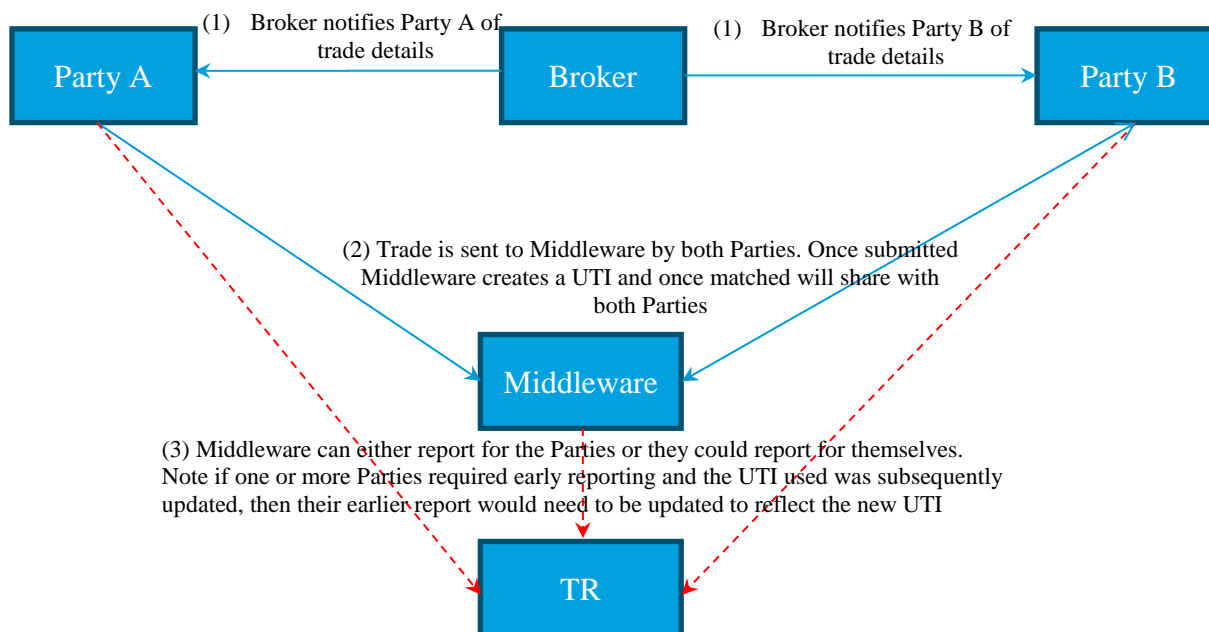

Middleware generates a UTI when the first trade is submitted. If the subsequent submission matches, then the UTI will be shared and consumed by both Parties. Once matched, the Middleware will determine the correct UTI and notify both Parties who will need to consume, and if applicable, update their reference to match.

In the occasional instance where trades get confirmed via Middleware or an electronic confirmation platform which does not offer UTI generation or reporting services, the UTI generation guidelines for paper confirmed trades would apply. See Appendix 7.3 “Determination of the UTI Generating Party” for these guidelines.

5.2.3 Paper Trades

There is no central execution and no Middleware for confirmation matching; trades will be paper confirmed. If the other Party receives the agreed UTI before the reporting deadline, then they should also include the UTI on their Confirmation. However, if the other Party has not received an agreed UTI before the reporting deadline, they may submit their own trade reference, but not report a UTI until a UTI is agreed, at which time they should update and report with the agreed, final UTI.

To determine who generates the UTI when there is no central execution platform, see Appendix 7.2 “UTI Generator - Decision Tree.”

In the example shown, Party B is the UTI generator.

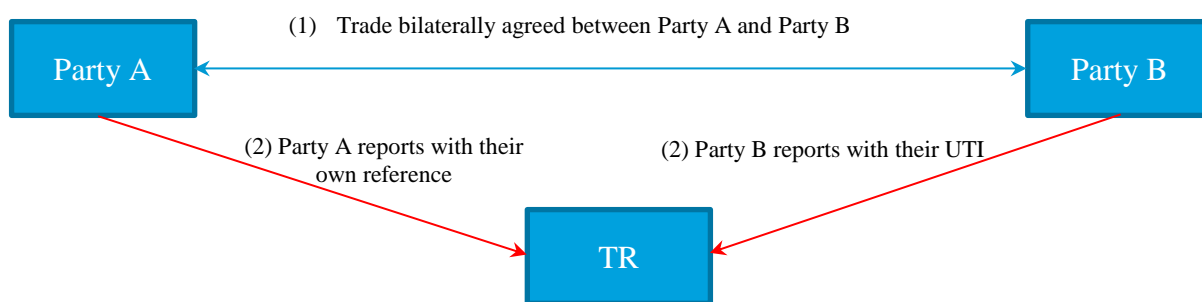

One Party will be required to update their reference to match that of the determining Party.

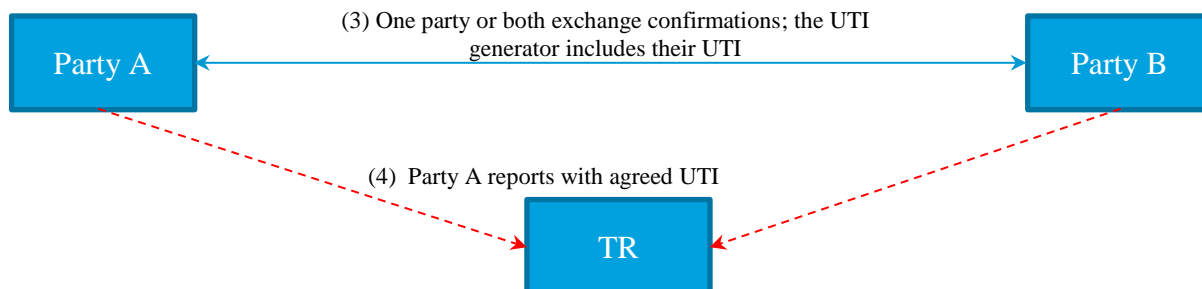

5.2.4 Affirm in Middleware – Cleared trade example (extension of scenario 4.2.1)

There is no central generation or exchange of UTI at point of execution.

Alpha

One Party/Broker alleges the trade in the Middleware system for the other Party to accept. Middleware system will generate a UTI, which will be shared and consumed by both Parties to the trade

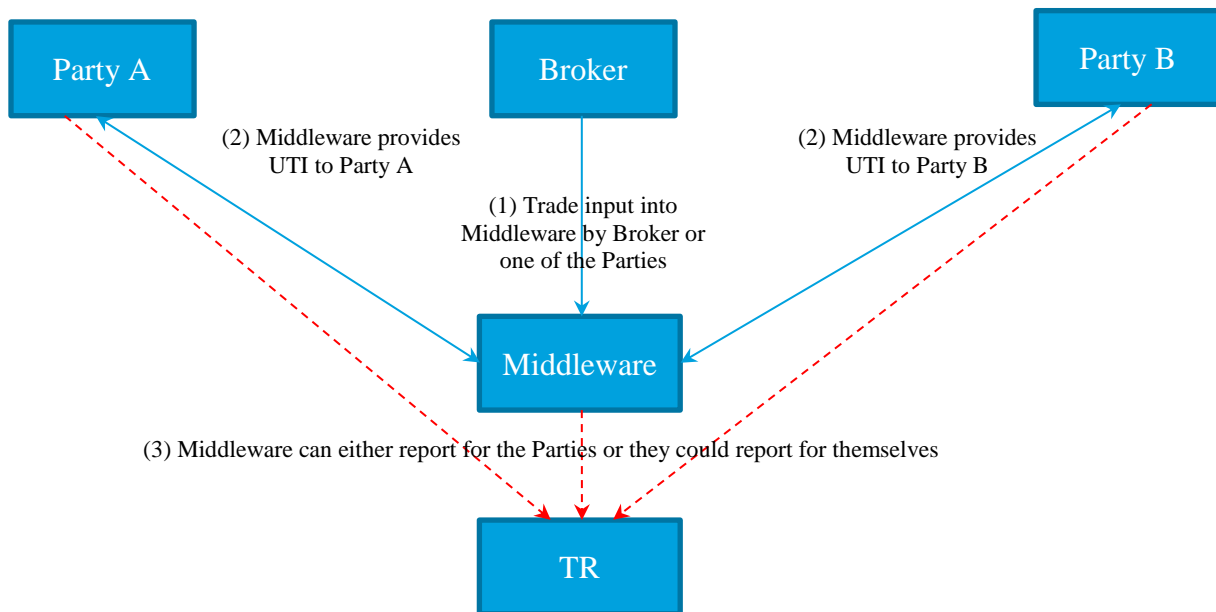

Beta/Gamma

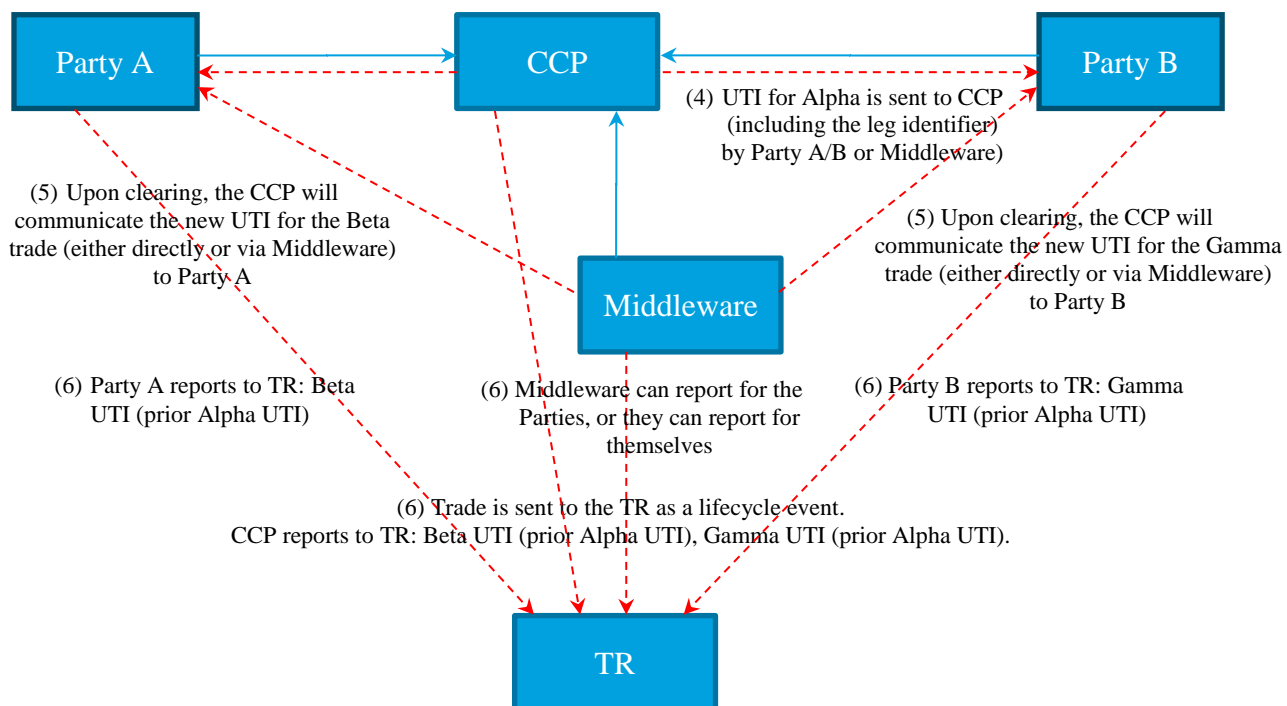

5.3 Cleared Trades

The following diagrams are intended to generically represent common flows for cleared swaps for purposes of communicating the UTI. Not all flows will apply to all asset classes, nor will all CCPs support all flows.

For simplicity of illustration, the cleared trade scenarios show reporting to one TR, however, it is possible that reporting could occur to separate TRs.

5.3.1 Unlinked Principal Trades

5.3.1.1 New Trade

The Unlinked model implies no linkage between the two cleared sides.

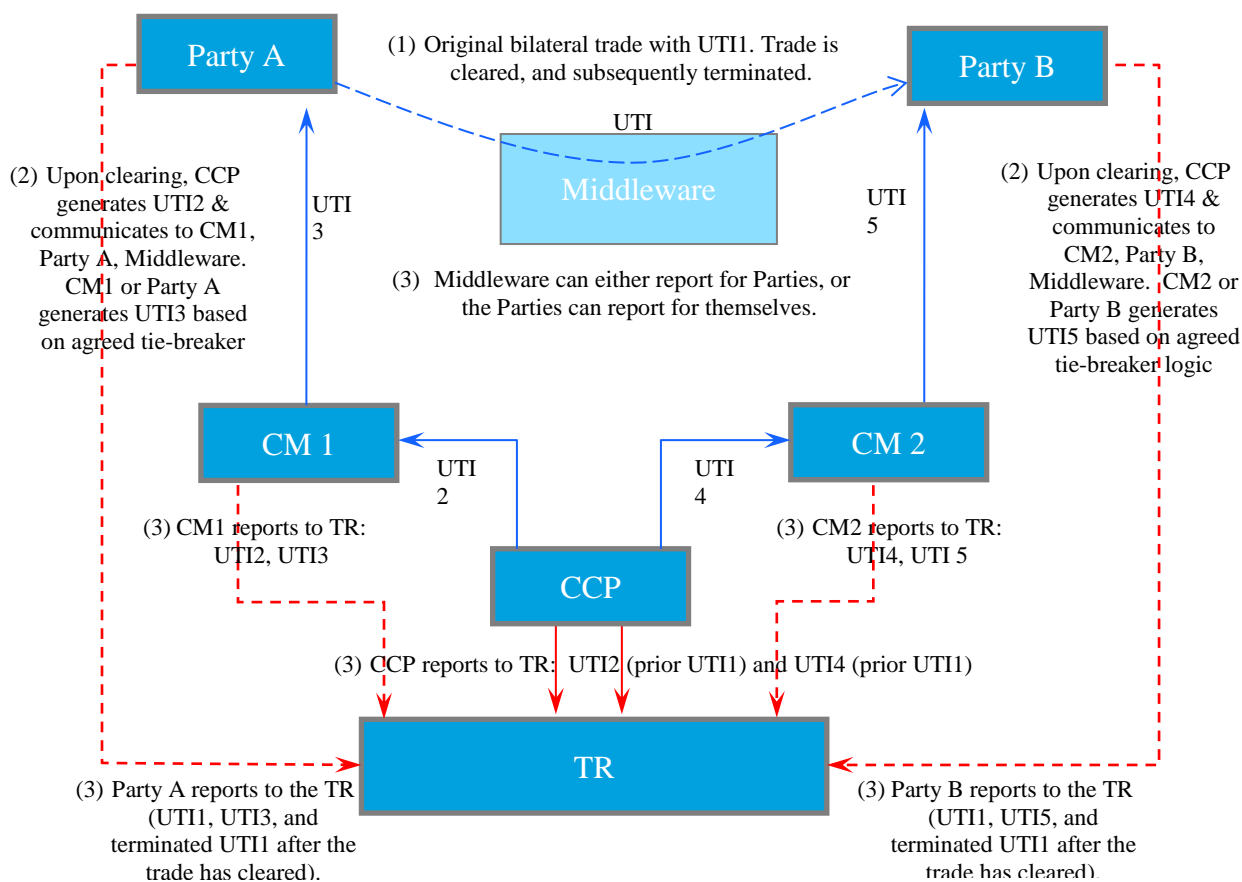

5.3.1.2 Allocated Trade

This example illustrates a pre-clearing scenario. Once trades are sent for clearing, then the flows are identical to "Unlinked Principal Trades - New Trade" shown in section 4.3.1.1.

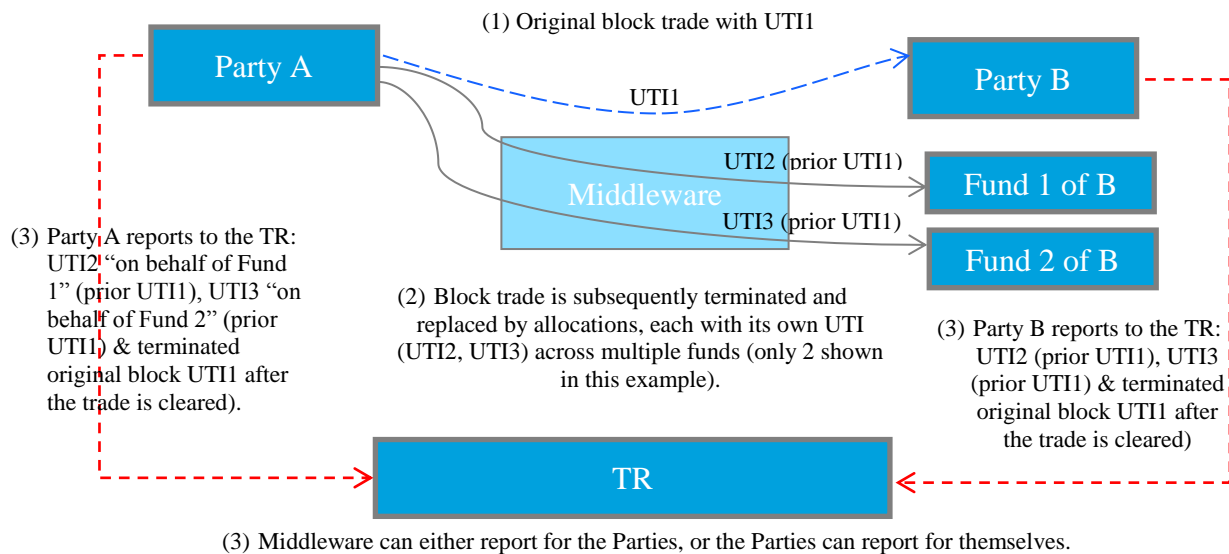

5.3.1.3 Portfolio Transfer

The trade between original Parties is agreed & already has a UTI (UTI1, UTI2). The portfolio is now being transferred from Clearing Member 1 (CM1) to CM3.

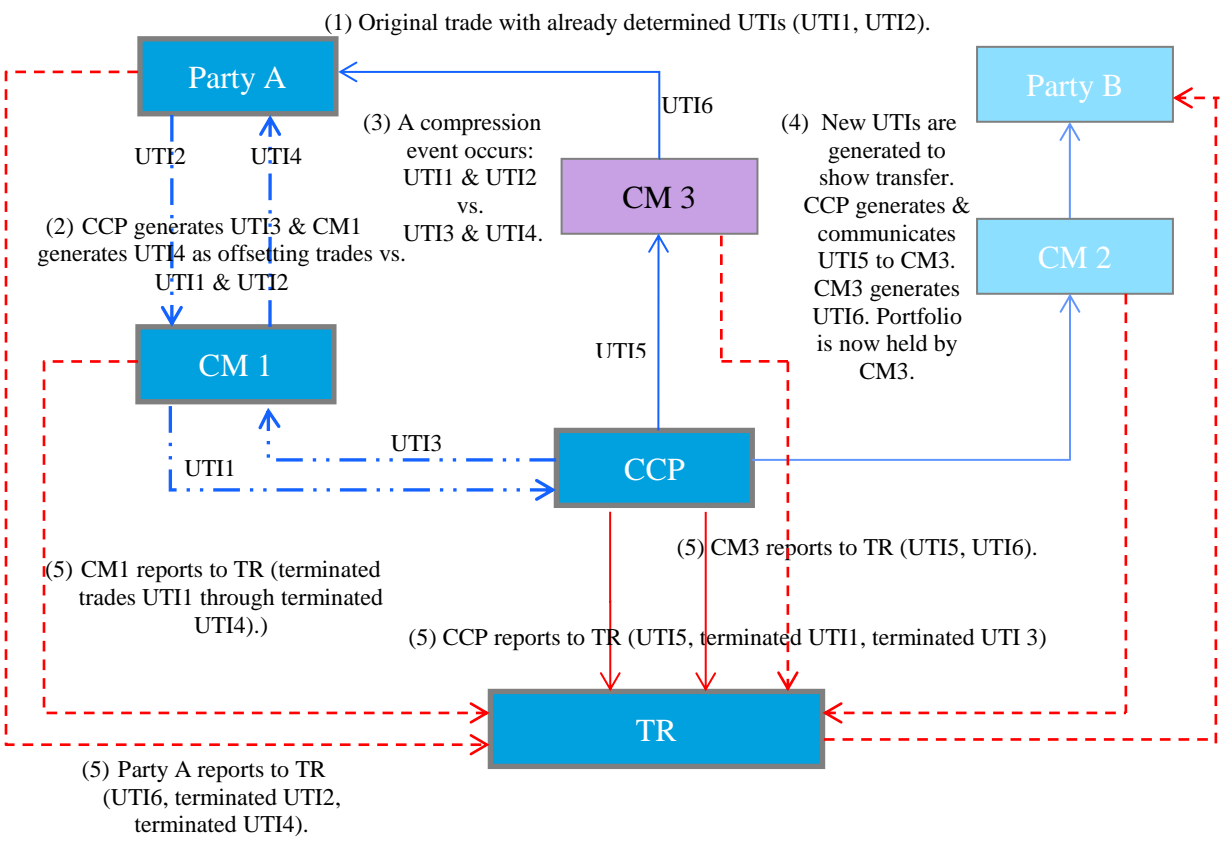

5.3.1.4 Compressions

In a compression, multiple trades already exist and have cleared. The original trades are closed per Client request by executing a new trade in an offsetting position to the original trade. In a full compression, no residual amount remains after netting, so no new trade arises (e.g., no new UTI generated). Both original trades are terminated. In a partial compression, a residual amount remains after netting, and a new trade for the remnant is created with a new UTI. The compressed original trades are terminated.

A partial compression, which is a post-clearing event, is illustrated here. In a full compression, new UTI5 and new UTI6 would not be generated.

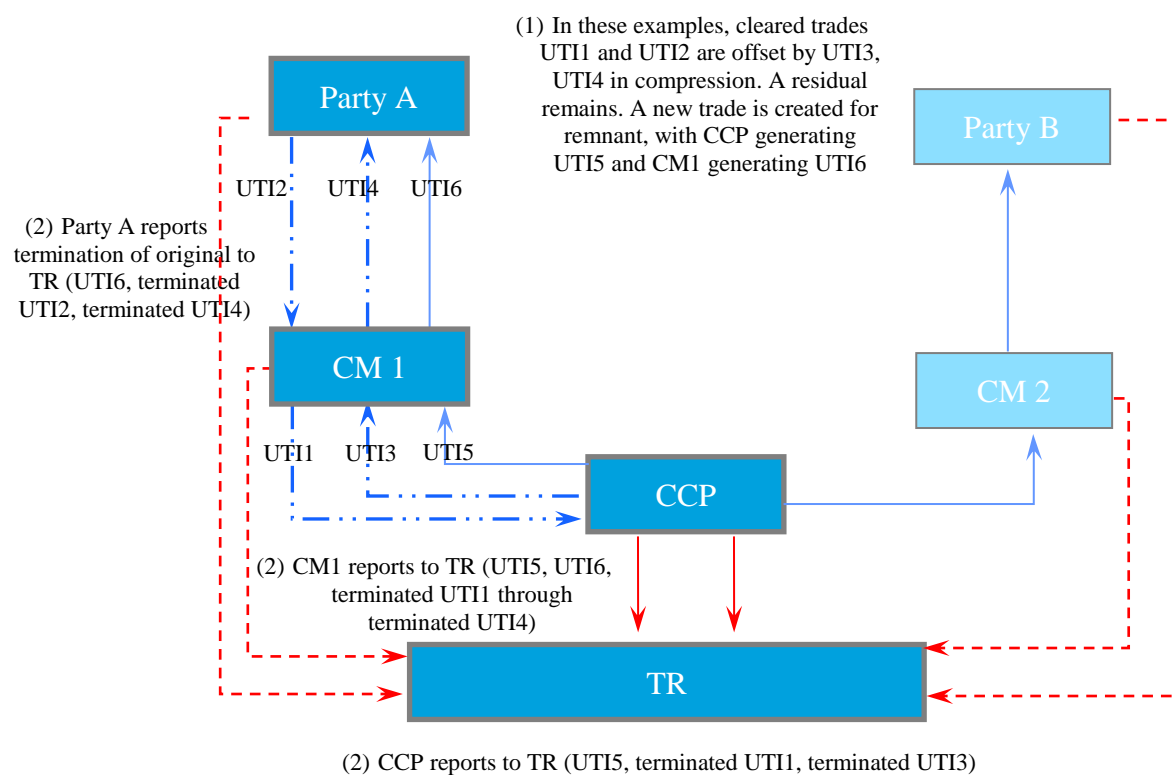

5.3.2 Unlinked Agency Trades

In Agency trades, the CM may report trades, but does not have an obligation to do so.

5.3.2.1 New Trade

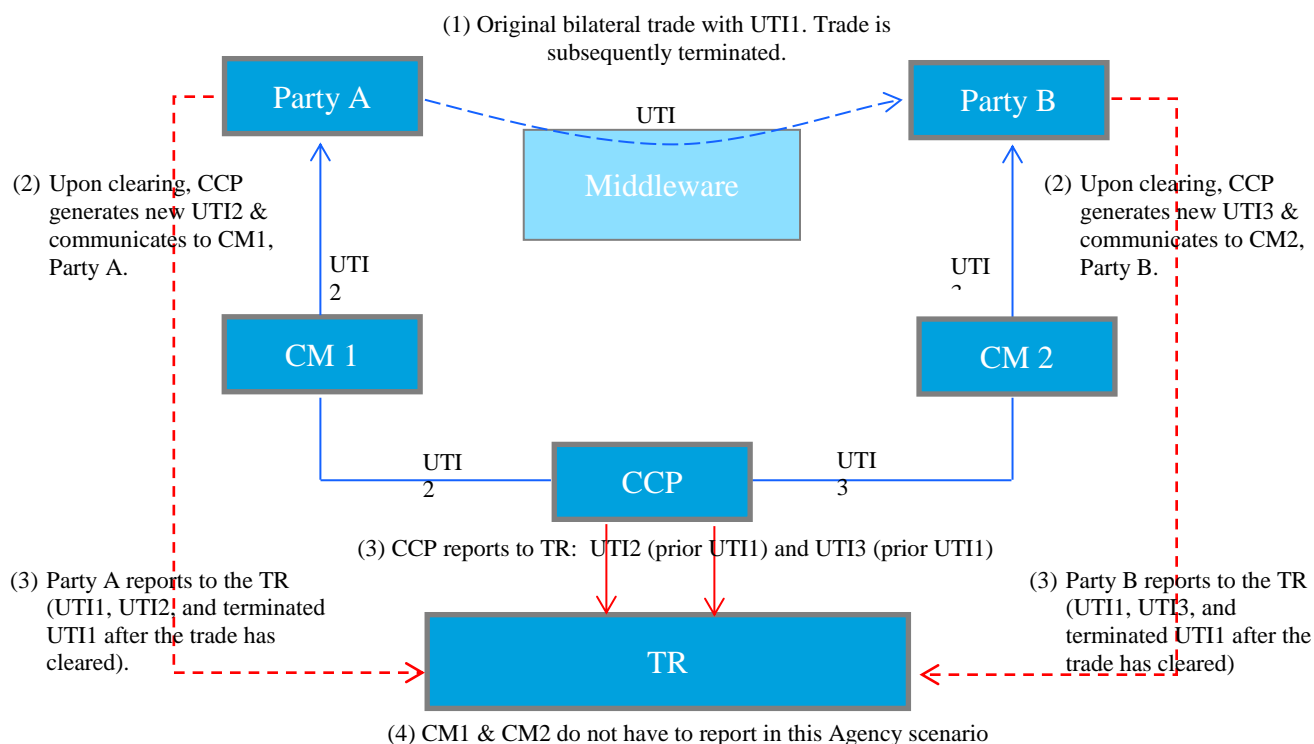

5.3.2.2 Portfolio Transfer

The trade between original Parties is agreed & already has a UTI (UTI1). The portfolio is now being transferred from CM1 to CM3.

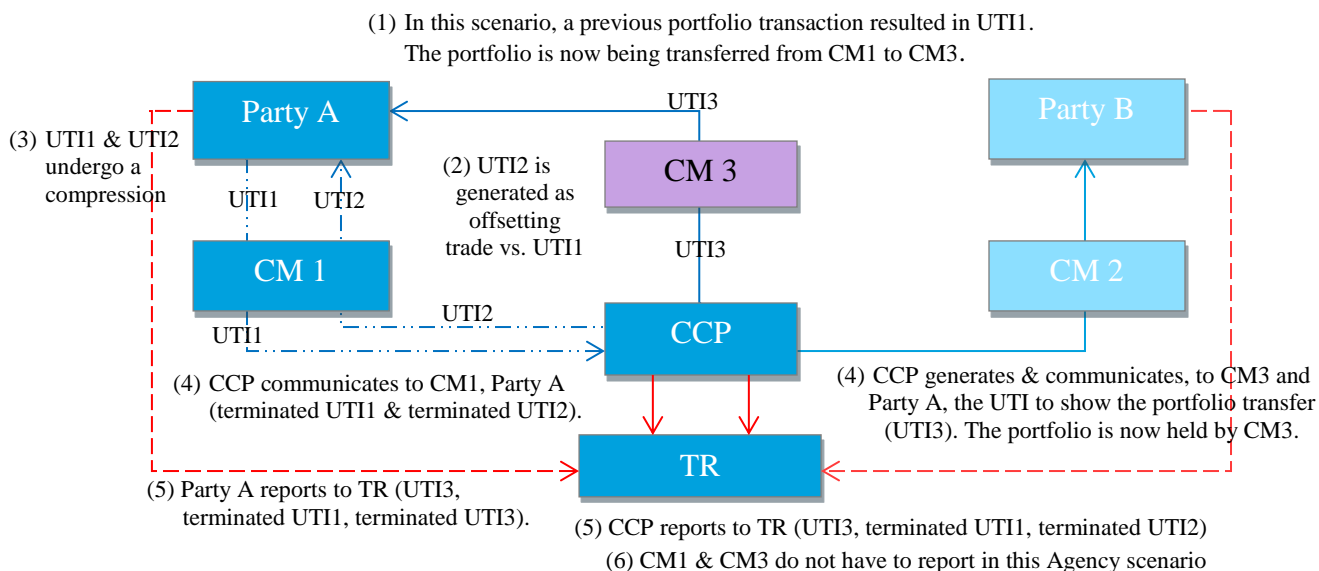

5.3.2.3 Compressions

In a compression, multiple trades already exist and have cleared. The original trades are closed per Client request by executing a new trade in an offsetting position to the original trade. In a full compression, no residual amount remains after netting, so no new trade arises (e.g. no new UTI generated). Both original trades are terminated. In a partial compression, a residual amount remains after netting, and a new trade for the remnant is created with a new UTI. The compressed original trades are terminated.

A partial compression, which is a post-clearing event, is illustrated here. In a full compression, new UTI3 would not be generated.

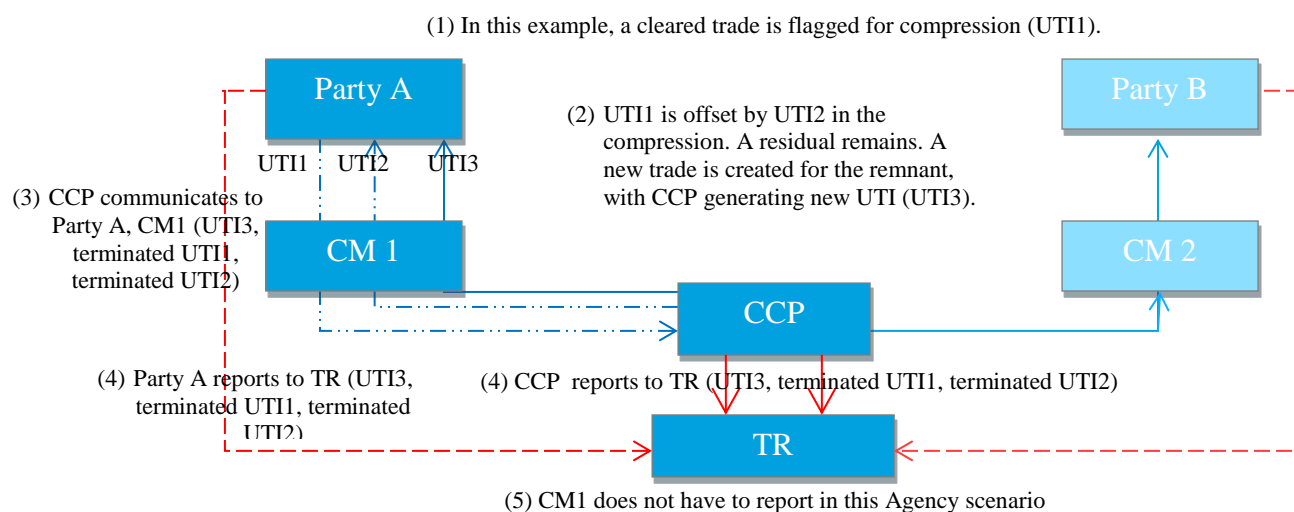

5.3.3 Linked Trades

Linked trade scenarios apply to certain interdealer trades, where both Parties are Clearing Member

5.3.3.1 New Trade

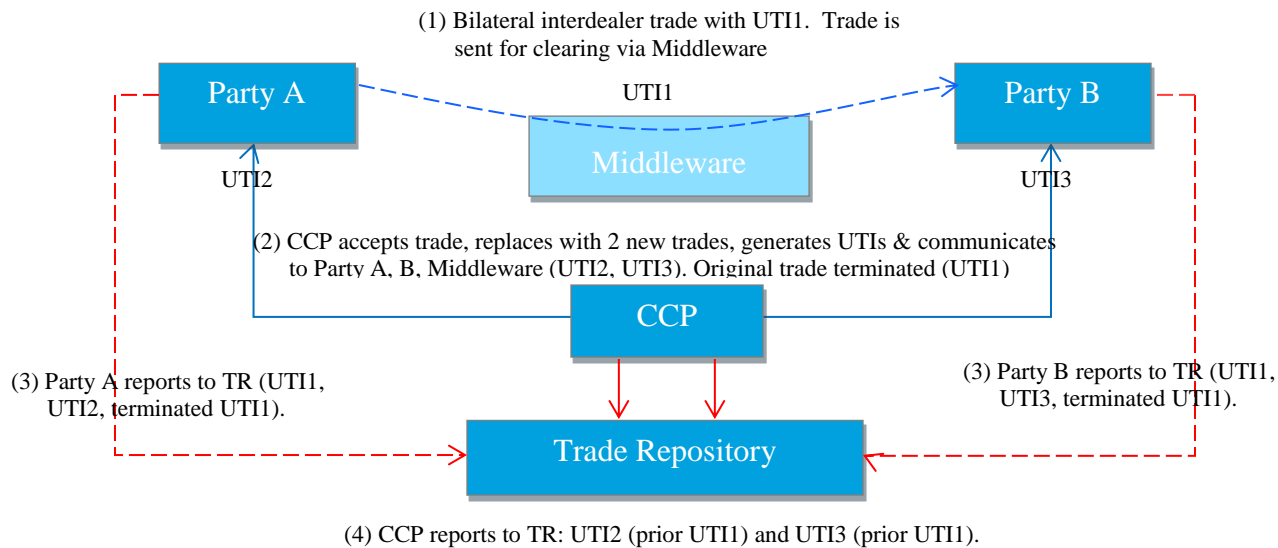

5.3.3.2 Existing Trade - Lifecycle Event

Original bilateral trade with UTI1 generated by Middleware already exists with a UTI (UTI1). A Lifecycle event results in a declare. Any actions which occur after declaring result in a new trade for clearing.

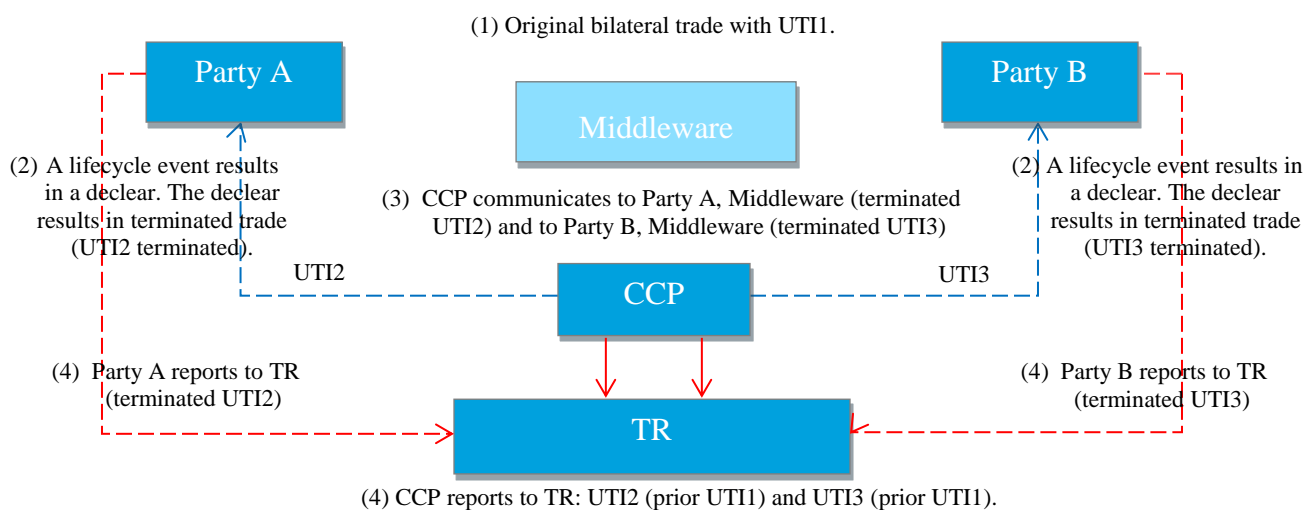

5.3.3.3 Existing Trade - Position Transfer

The original trade is agreed and already has a UTI (UTI1). A position transfer results in the transfer of one side of the cleared trade from Party A to Party C. The transfer creates a new contract between Party C and the CCP which will have a new UTI.

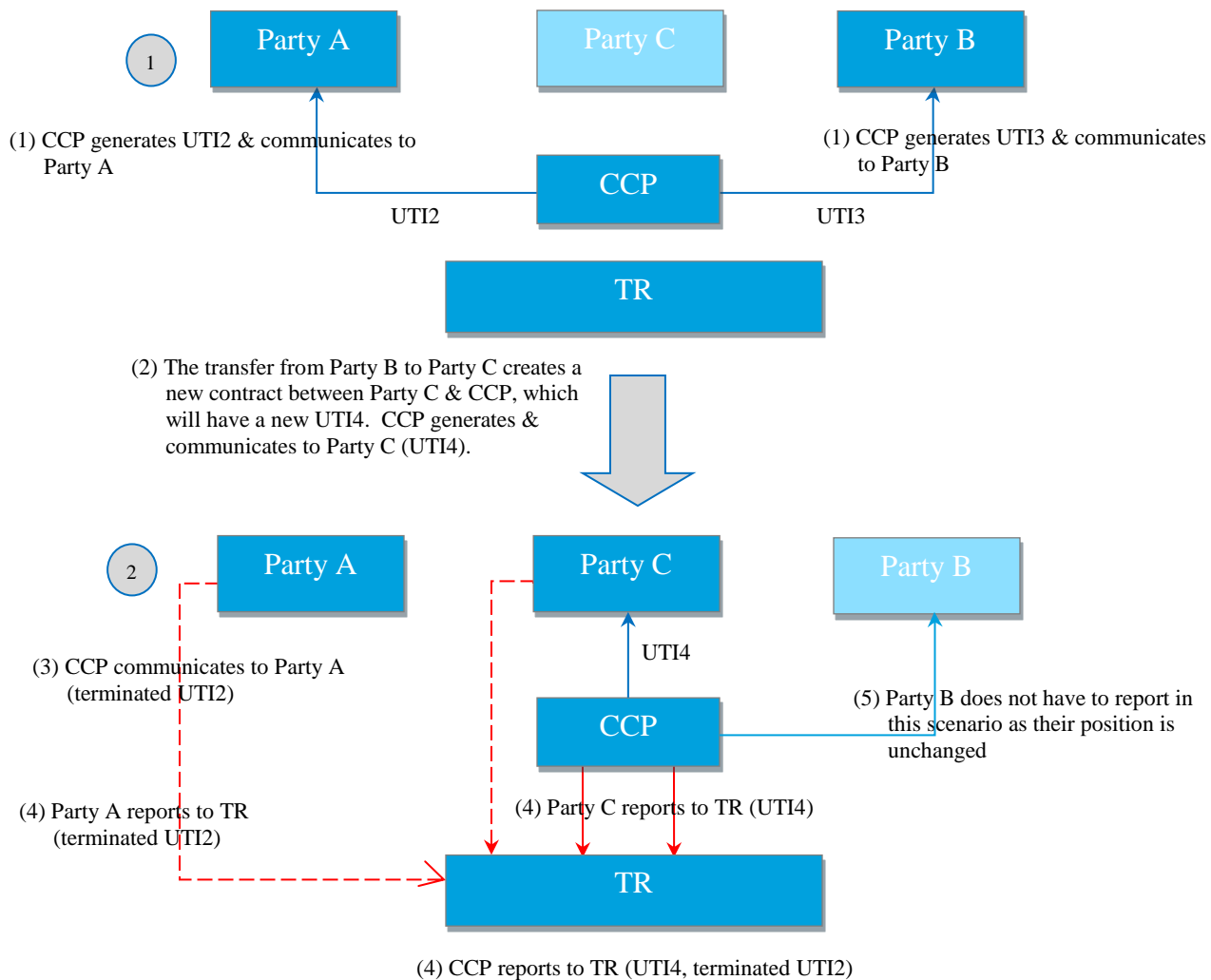

5.4 Novations

5.4.1 Novated over Middleware

The trade between the original Parties is agreed and already has a UTI.

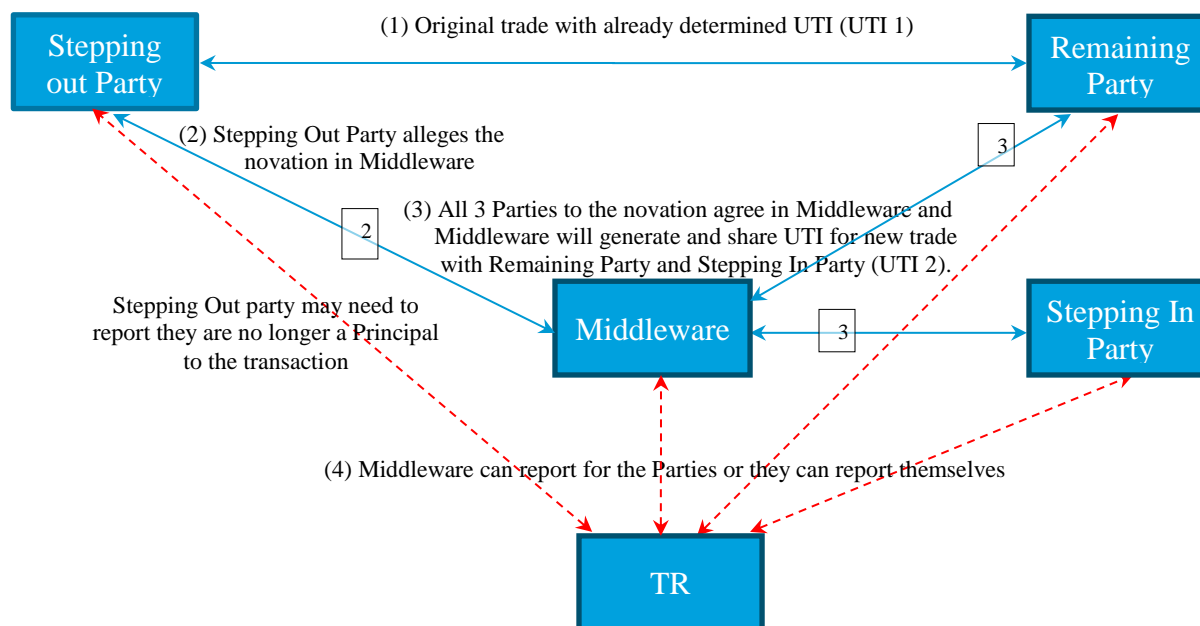

In the case of creation of a new UTI, a reference to a prior UTI will be required (see "Creation of UTI - Event Table" in Appendix 7.1).

5.4.2 Novation on Paper

Work flow is the same as for paper trades. UTI needs to be shared as part of the confirmation process. Upon novation, the party responsible for generating the UTI creates it. The UTI needs to be shared as part of the Confirmation process.

5.5 Prime Brokerage Flows

For Prime Brokerage transactions, Parties can reference a prior UTI if required by a Regulator. In general for Prime Brokerage, the ED is the UTI generator for the ED/PB leg, while the PB is the UTI generator for the Client/PB leg.

5.5.1 With Middleware

If the Client is acting as Agent to the PB during the transaction negotiation, the PB may report on behalf of the Client. The PB/Client leg and PB/ED leg are reportable, the ED versus Client leg is not, and the flows are shown below. If the Client is acting as Principal, then the process follows the model depicted in Section 4.3 "Novations."

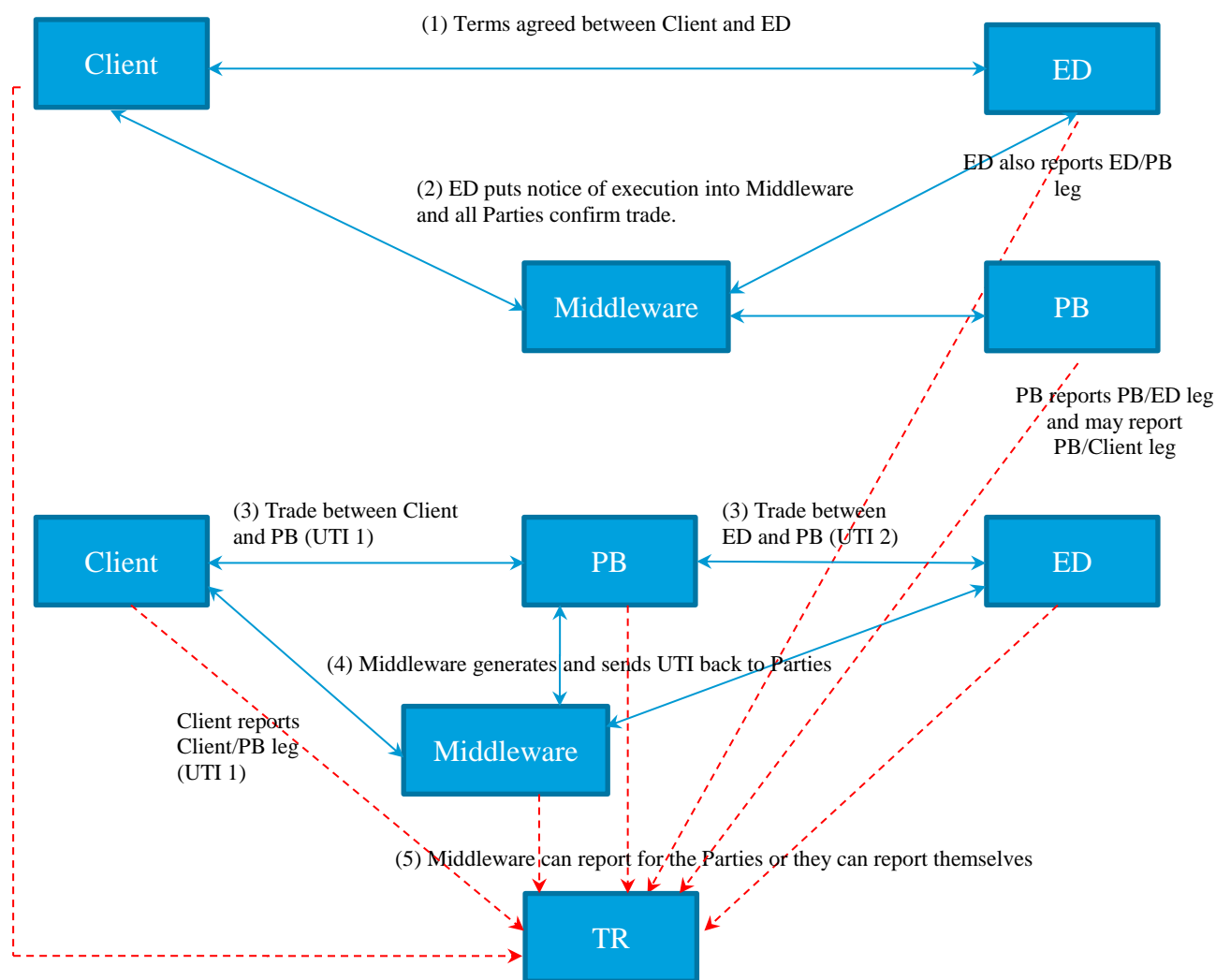

***Note:** Execution time for PB-reported trades is the time the trade was accepted by the PB. If Middleware is not generating the UTI, then it consumes the UTI from the UTI generator and shares with Parties.

5.5.2 No Middleware

This is for the scenario where there is no Middleware provider, such as in FX. There is no central generation and sharing of UTI. Client, ED and PB are Principal to the trade.

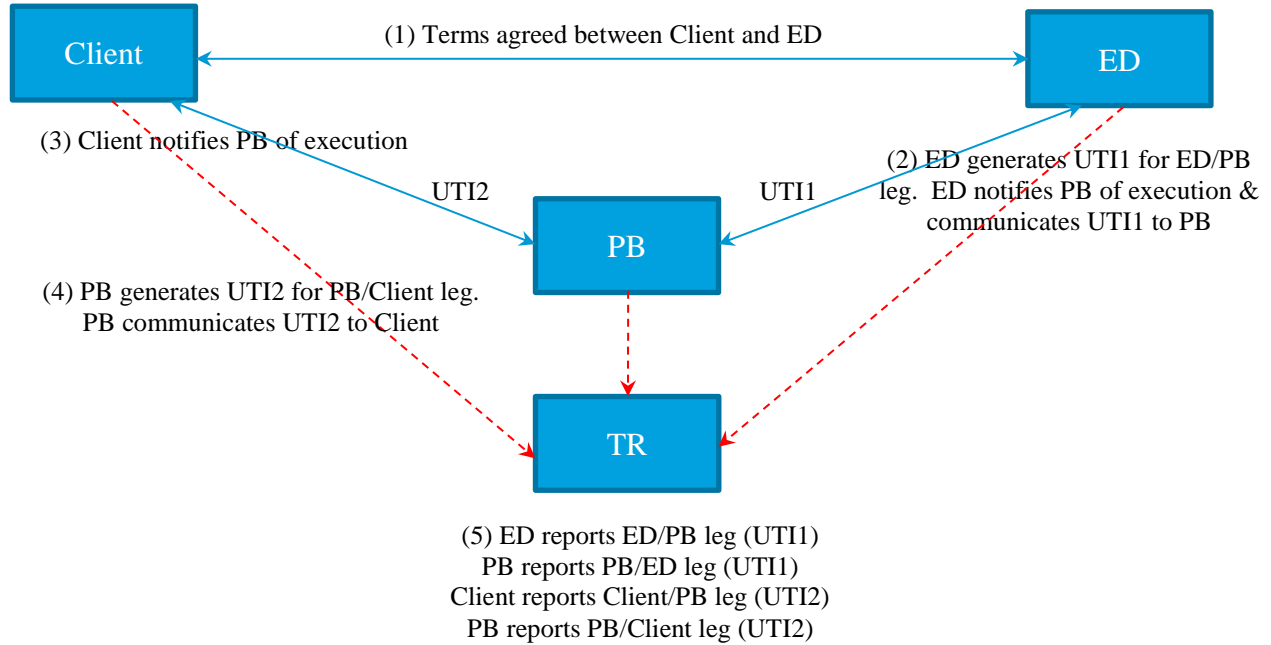

5.5.3 (a) Allocation(s) with preceding Block Trade

On the PB-Client side, funds are initially allocated to a single ED-PB block trade. The block trade is subsequently terminated and replaced by a split allocation across multiple PB-Client trades. Each has its own unique UTI.

In some jurisdictions, a requirement exists for the initial PB-Client block trade to refer back to the mirror ED-PB trade. Each of the Client-side allocation trades will have the UTI of the trade they replaced in the trade repository.

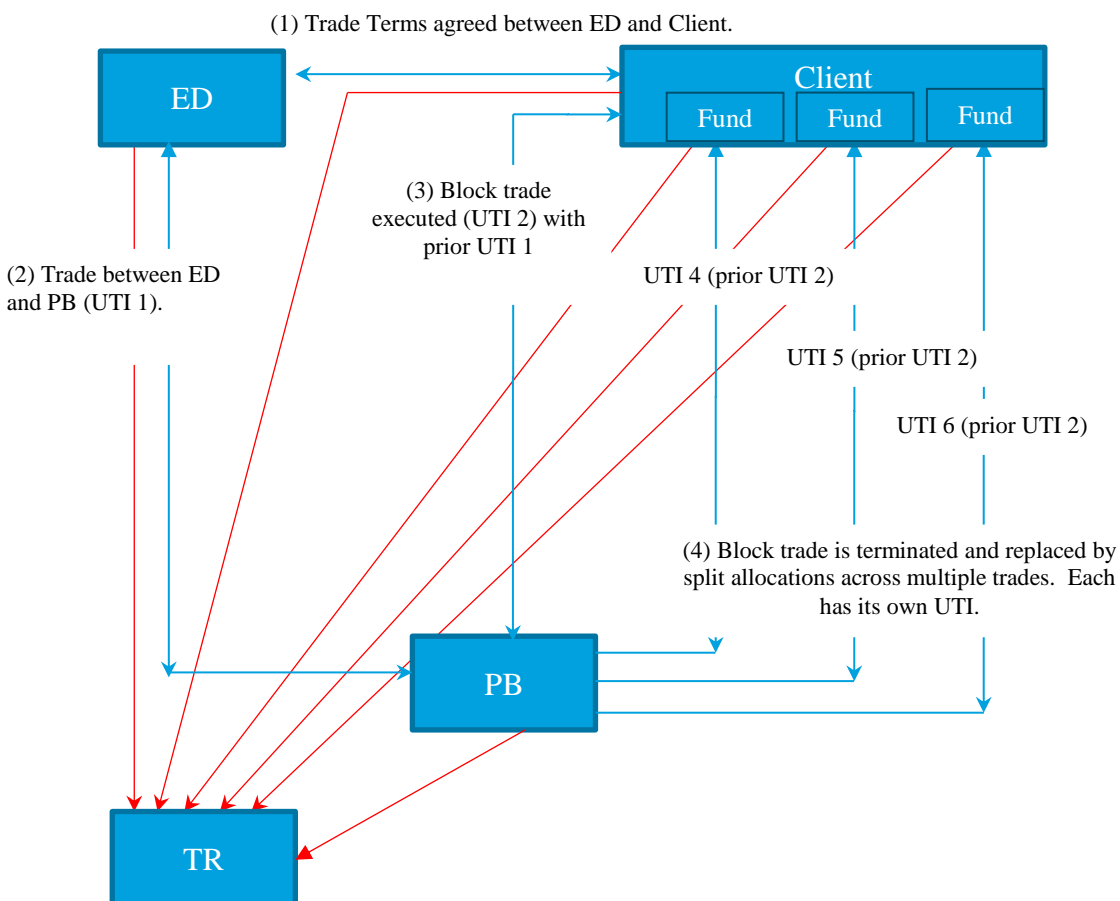

5.5.3 (b) Allocation(s) with no preceding Block Trade

One-to-many PB transactions, with no preceding Client-side block trade. On the PB-Client side funds are split across allocations over multiple deals.

In some jurisdictions, a requirement exists for each PB-Client trade to refer back to the mirror ED-PB trade.

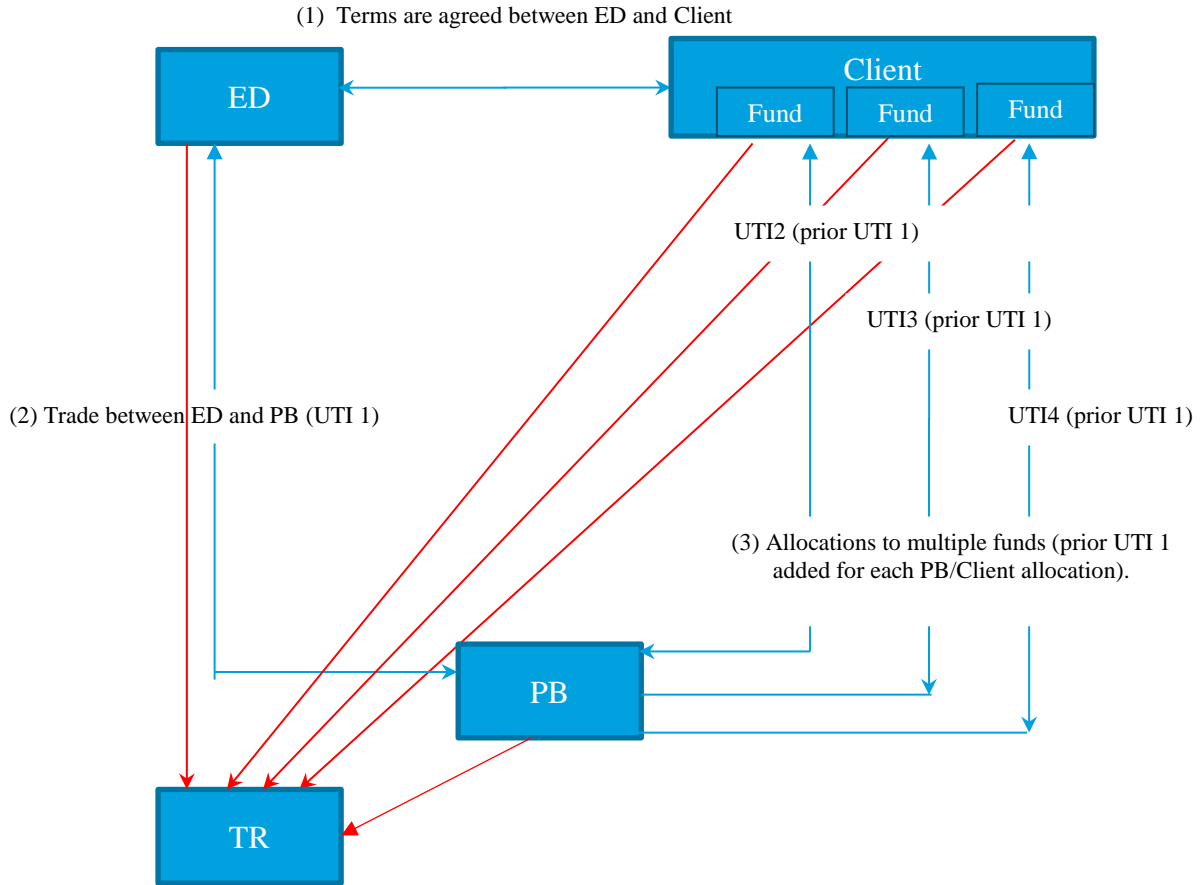

5.5.4 (a) Novation when original trade has cleared

In this case, the trade cannot declare on the PB/Dealer leg. Client has an existing rates transaction with ED1. In this case, the original trade (PB / ED1) has cleared. ED1 is depicted to demonstrate that ED1 would not be involved since the original transaction between ED1/PB was cleared. The PB/Client leg remains bilateral.

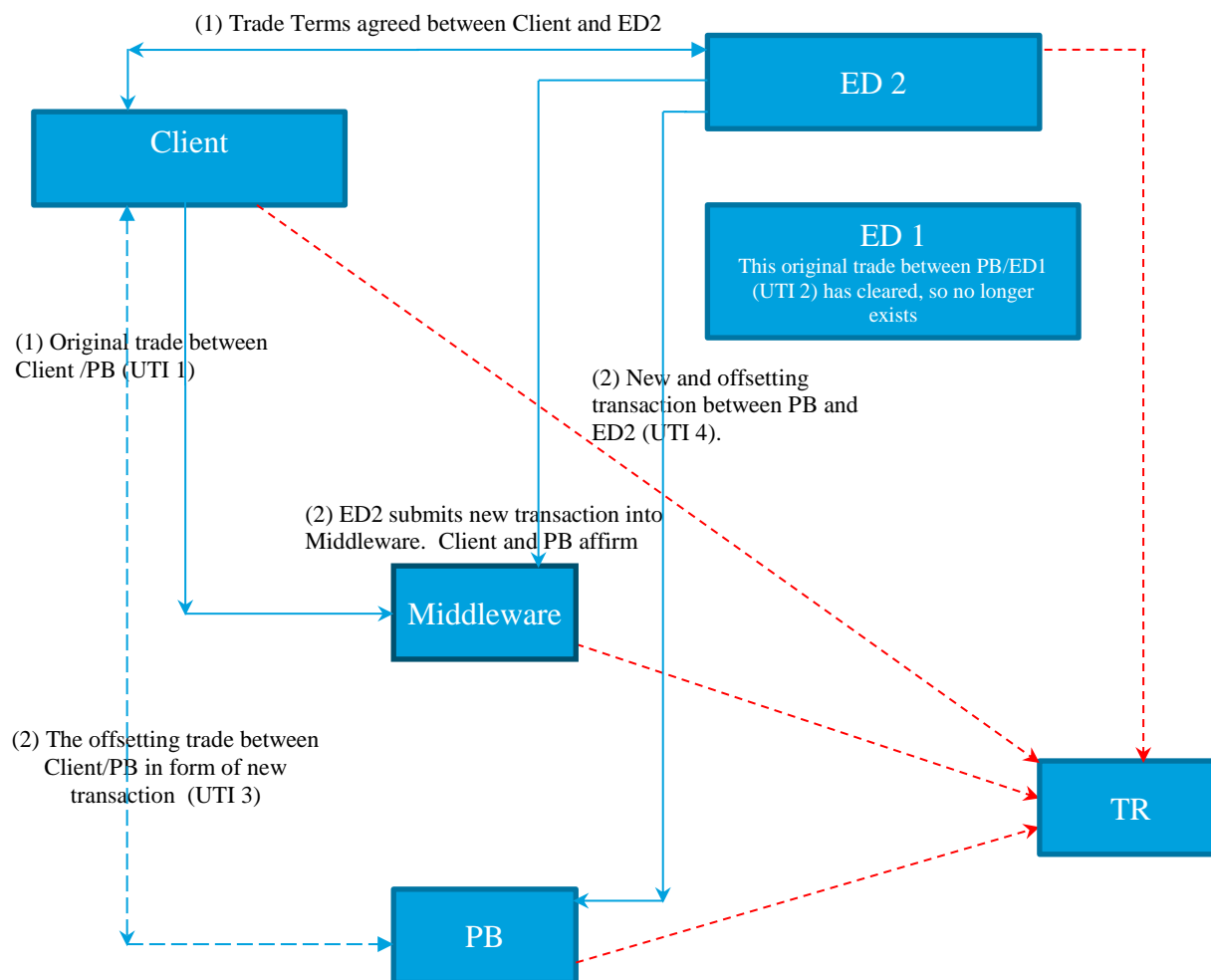

5.5.4 (b) Novation when original trade has not cleared

Client has an existing transaction with ED1 in rates. In this case, the original trade (PB / ED1 leg) has not been cleared.

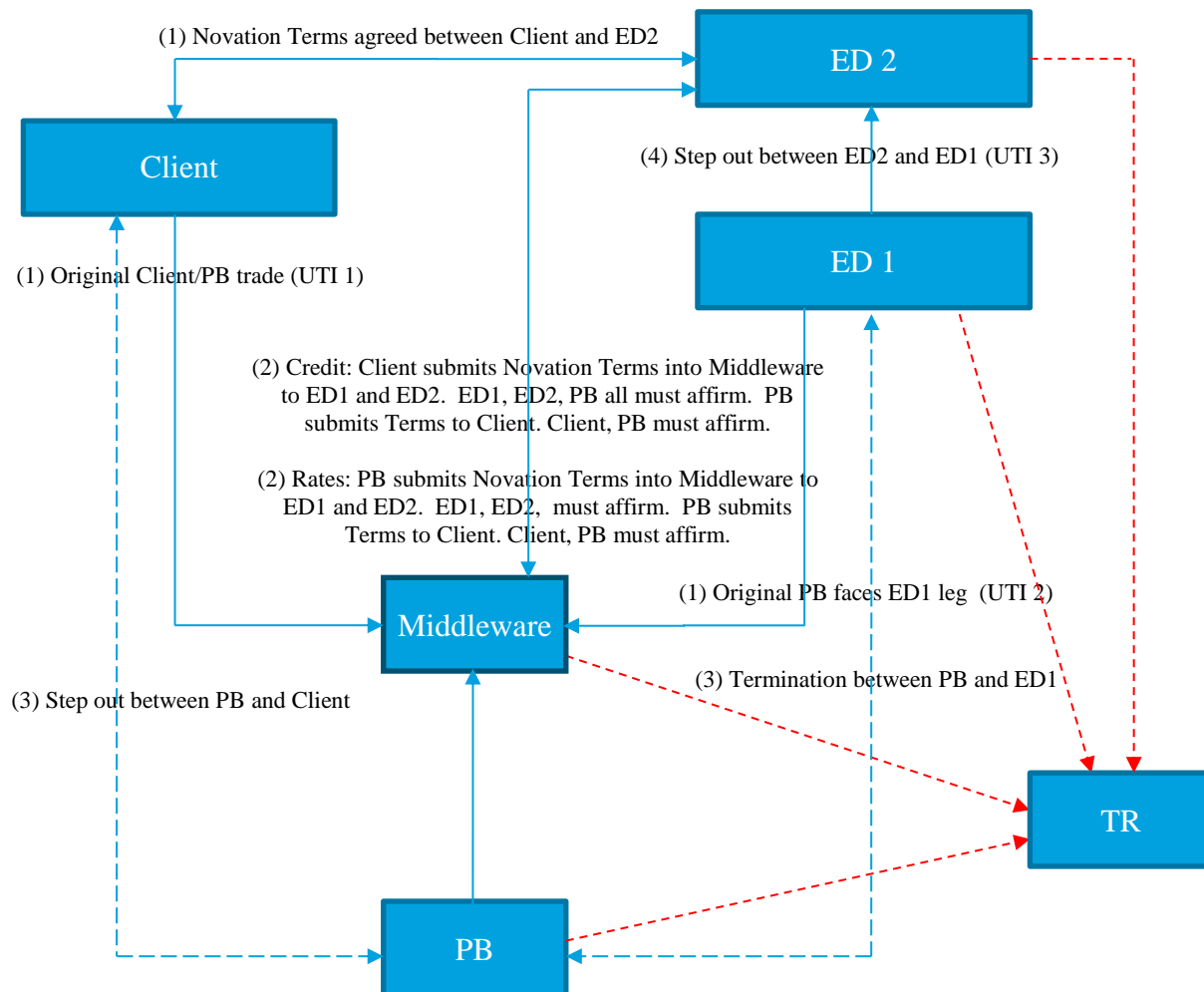

5.5.5 (a) Unwind when original trade has cleared

In this credit scenario, the original trade (PB /ED) has been cleared, and cannot de-clear. The majority of Dealers are currently voluntarily self-clearing. Execution occurs with the same ED as the original trade.

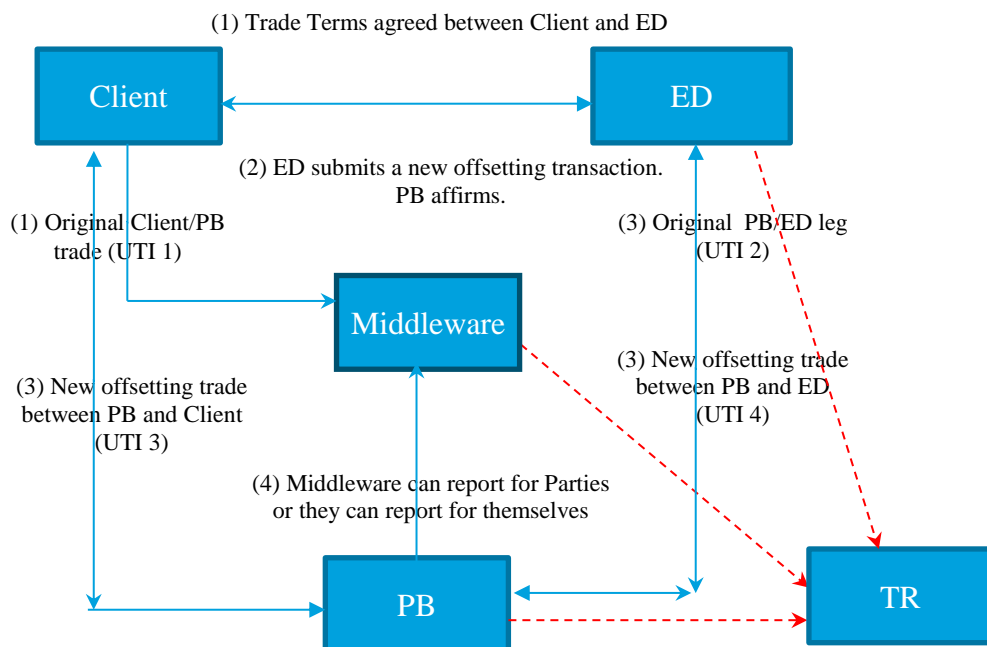

5.5.5 (b) Unwind when original trade has not cleared

This is a case where the original trade (PB /ED) has not been cleared for credit or rates. Executing with the same ED as the original trade.

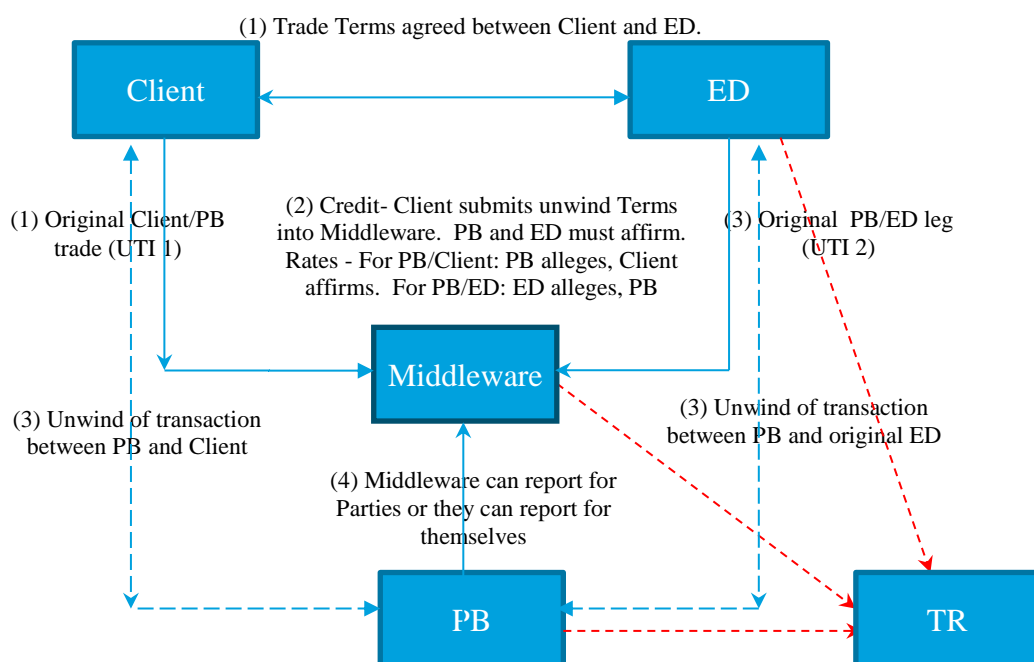

5.5.6 PB executes full compression for Client per Client request

A plain vanilla trade already exists for rates or credit. Multiple trades are closed by PB for the Client, per the Client's request, and replaced by a single trade by executing a new trade in an offsetting position. Client tells PB which positions to compress. A full compression is when 100% of the Clients' individual trades are terminated, and no residual position remains for the Client and PB. If a residual position is left, the trades may be terminated, and a new trade created (with a new UTI) for the remnant. The compressed trade which was closed would refer back to the new trade. There may be cases where this may not always be followed, and, if a residual position is left, the trade could possibly be amended in terms of amount and keep the same UTI.

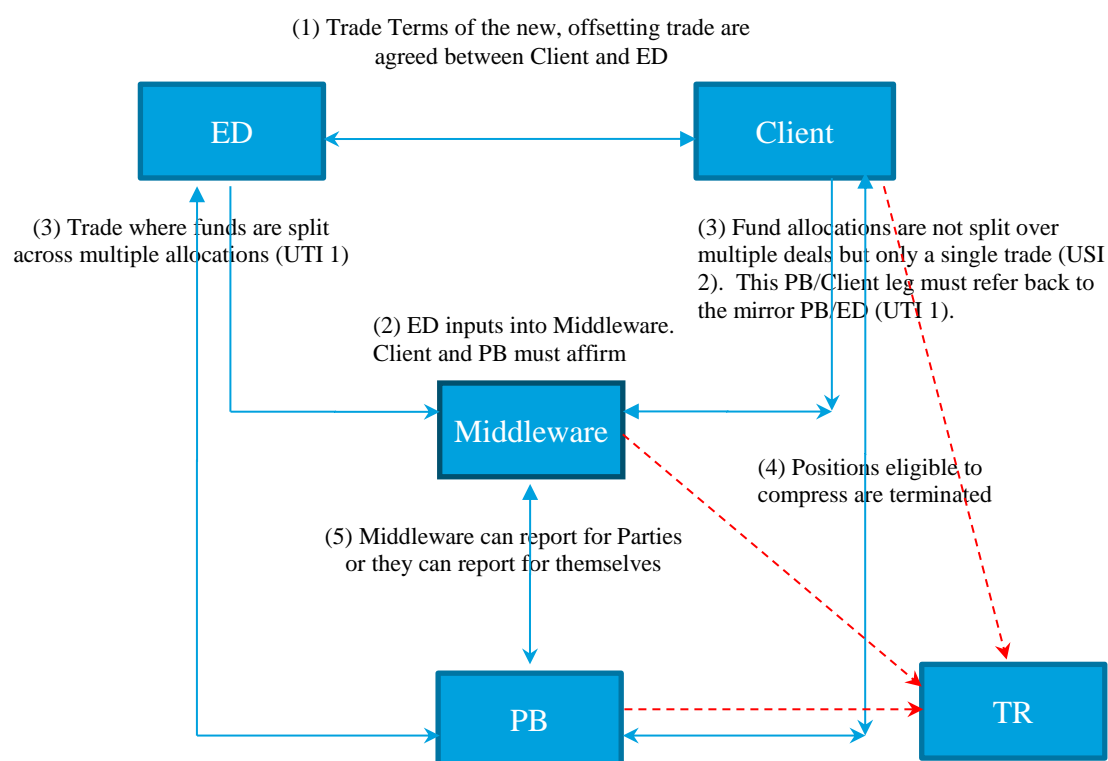

5.5.7 Intermediations

Trade Terms are agreed between Client and ED, and the trade is confirmed with UTI 1. The trade is bilateral. At the point of execution, there is no give-up, but then subsequently given-up. The PB intermediates e.g., the PB steps in between to face the Client and the ED. A new UTI must be generated and prior UTI 1 is referenced. This depicts a fundamental flow - there are additional scenarios which also use Middleware to communicate the UTI and match on common data fields.

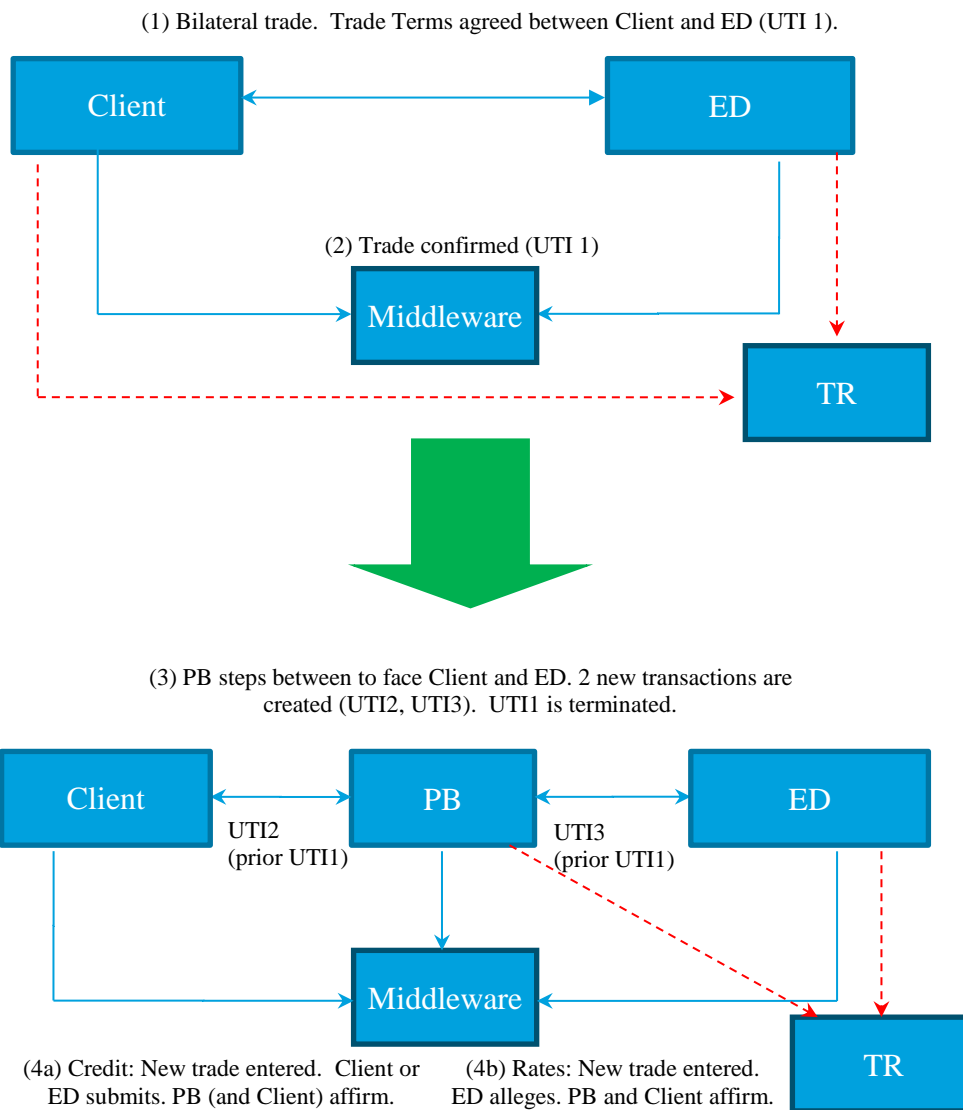

5.5.8 Negative Affirmation: Prime Equity Synthetics Front-to-Back Workflow

The PB is the ‘determining party’ as the writer and seller of the swap. Therefore, the PB generates the UTI for consumption by the Client/Hedge Fund. The UTI is created in-house and negatively affirmed to “agree” on common data.

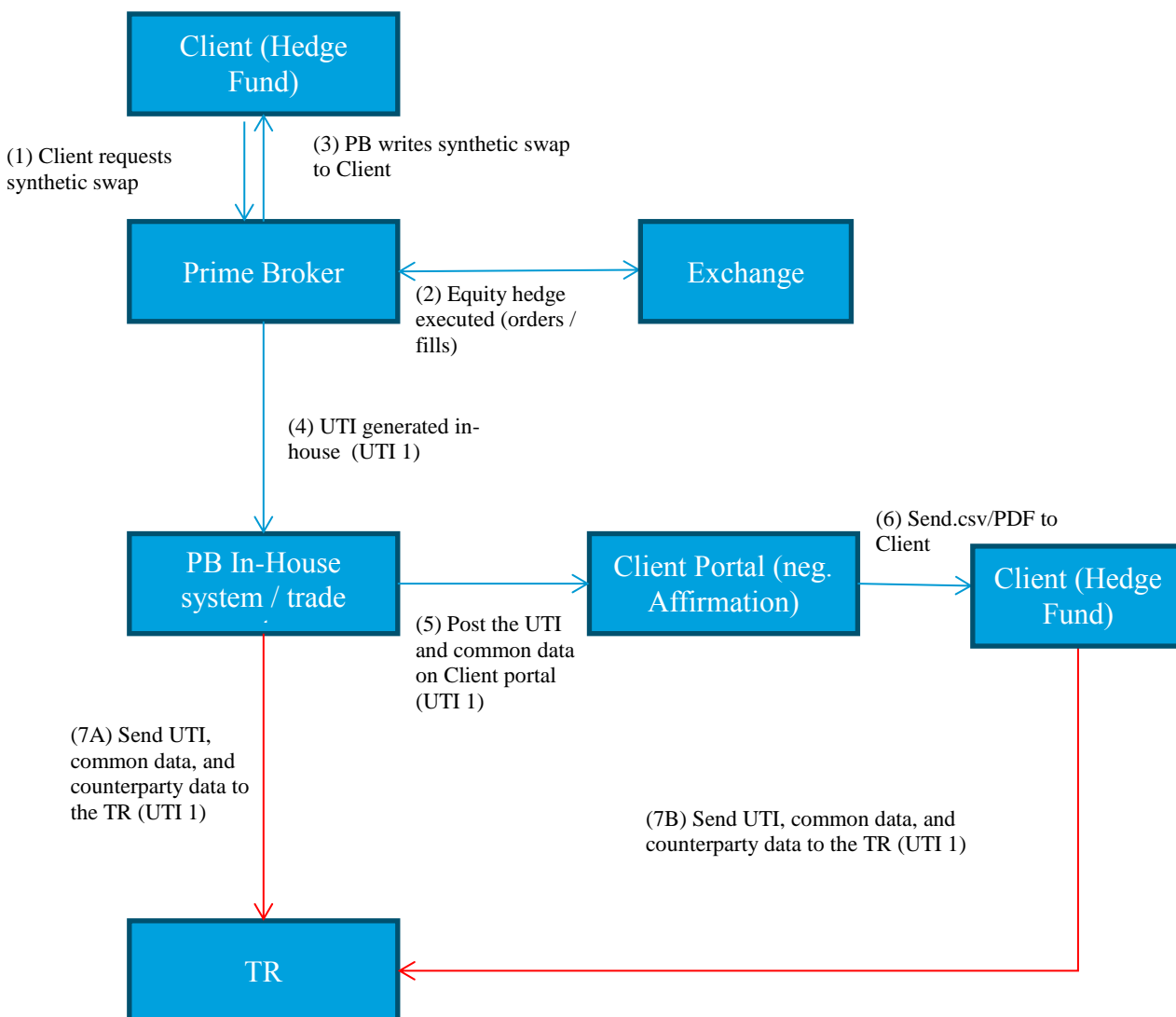

6 UTI Generation and Matching for Historical Trade Populations

6.1 Summary

In jurisdictions where Parties need to report historic trades with an agreed UTI⁷, historic trades need to be paired and matched in advance in order to agree a UTI. Firms will need to participate in a bilateral pairing exercise with their Counterparties to confirm their eligible trade population, as well as to agree UTIs for trades. Priority for UTI determination would apply first to live trades.

6.2 Principles

The following principles are proposed industry best practice for determining a UTI for historic trades.

- 1 Where an acceptable unique trade reference is available via Middleware, electronic confirmation or execution platforms, that unique reference will be used as a UTI.
- 2 Counterparties should pair paper trades and agree a UTI ahead of reporting.⁸
- 3 For cleared trades, only the Beta and Gamma trades will be backloaded as live trades, as the Alpha trade is considered dead.
- 4 If a trade has already been reported under another jurisdiction (e.g. Dodd Frank or JFSA), then the UTI for any additional jurisdictions should be the same reference already used to report to the previous jurisdiction.
- 5 For a trade already reported under another jurisdiction, only the latest version of the trade will be backloaded as reportable.
- 6 For paper trades, the Party that generates the UTI should be determined using asset class specific logic. Examples can be found in the Appendix 7.3 "Determination of the UTI Generating Party."

⁷ TR Q#4c of the 24 October 2014 ESMA Q&A states that "To the extent that a backloaded contract is still outstanding at the time of reporting, a Trade-ID needs to be agreed between the two counterparties and reported, together with the other information on that contract." In line with the industry's interpretation, counterparties are not required, for EMIR, to pair an agreed UTI for non-live historical populations; parties are able to report their own internal reference number as the UTI instead. Non-live historical populations for this purpose are defined as trades which were no longer outstanding prior to EMIR reporting start date of 12 February 2014. Trades which were still outstanding on 12 February 2014 will still need to be reported with a paired UTI.

⁸ See §5 "Notes Applicable to Workflows" for additional information.

7 Appendices

7.1 Creation of UTI - Event Table

Certain events that result in a change to the legal part(ies) of a transaction require a new UTI to be generated. Whenever a new UTI is generated, the prior UTI is retained.

To further summarize the UTI principles, the following event table was created by industry working groups.

Event Type		New UTI Generated?
New Trade		Y
Amendment (correction to the trade for any trade attribute or fee)		N
Cancel (trade booked in error)		N
Trade Allocated	Original Unallocated "Block" Trade	N
	Allocated Trades	Y (each allocation)
Cleared Positions	Original Bilateral Trade	N
	Cleared Position	Y
Termination / Unwind		N
Partial Termination / Partial Unwind / Partial Decrease		N
Increase / Decrease		N
Full Novation – for the transaction between Remaining Party and the Transferee		Y
Full Novation – 4 way		Y
Partial Novation – Partial Remaining Party	Original Trade	N
	New Trade	Y
Partial Novation – Partial 4 way	Original Trade	N
	New Trade	Y
Exercise	Original Option	N
Exercise (New Swap - Physically Settled)		Y
Prime Brokerage		Y
Succession Events	Rename	N
	Reorganizations	Y
Credit Events	Bankruptcy / Failure to Pay	N
	Restructuring	Y ⁹
Compression Events	Original Trade - Terminated	N
	Original Trade – Amendment	N
	New Trade	Y
CCP: Position Transfer (i.e. transfer of a trade between Clearing Members)		Y
CCP: Declare then Reclear		Y
CCP: Compression		Y

⁹ Depending on product type and triggering activity

7.2 UTI Generator - Decision Tree

If a central execution platform, Middleware or CCP has not generated a UTI, this decision tree maps the process for determining who generates the UTI for all asset classes.

If the Party consuming the UTI has not received the UTI by time of reporting, then the Party should report using their own trade reference. Once the UTI is agreed, the trade should be updated and re-reported.

For multi-jurisdictional transactions, if there is a CFTC reporting obligation, a CFTC compliant USI must be generated. In this case, the USI would be used as the UTI. If both Parties have a reporting obligation, and need to determine who generates the UTI, then use the guidelines below.

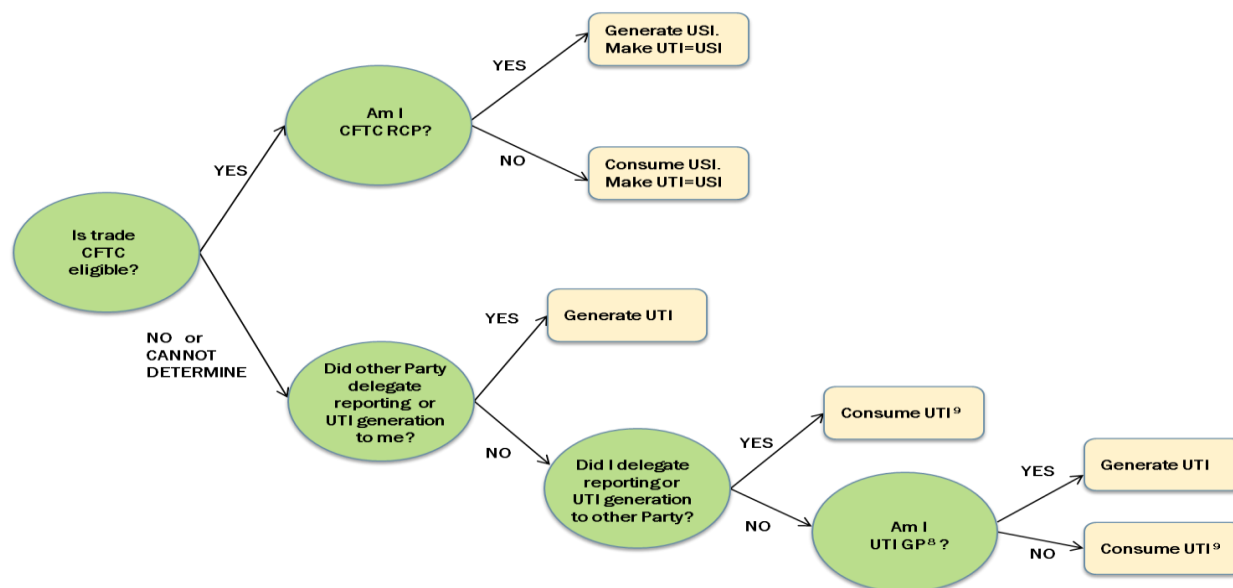

Note: We expect smaller banks /clients may delegate UTI generation to Dealers

We note that the Q&A on EMIR reporting issued by ESMA on October 24, 2014¹⁰ includes a suggested approach to UTI generation in TR Answer 19. It aligns with some of the key principles in this paper; however for parties of the same hierarchy it introduces jurisdiction and regulator specific classifications that are not suitable for a global standard. If both parties agree to do so, it is acceptable to follow the UTI best practice to determine the UTI generating party for EMIR reporting. However, if the parties fail to agree, then the hierarchy prescribed by ESMA in the Q&A would apply. As the ESMA approach is based on EU-specific classifications, it cannot be extended globally, therefore parties are encouraged to follow the UTI best practice.

⁸ If only one Party has a reporting obligation, they are automatically the UTI generator.

⁹ Parties with no reporting obligation may choose whether or not to consume the UTI.

¹⁰ http://www.esma.europa.eu/system/files/2014-1300_qa_xi_on_emir_implementation_october_2014.pdf

7.3 Determination of the UTI Generating Party

The process of USI/UTI generation and determination of Reporting Counterparty (“RP”) in singular reporting party jurisdictions are separate and distinct processes. The following is the best practice tie-breaker logic to determine which party generates the UTI.

Rates

Product Attribute Determination

RP Tie Breaker Logic - Rates		
Trade Type	Explanation	Reporting Party
Cap/Floor	When a single Fixed Rate Payer exists	Fixed Rate Payer. Otherwise Reverse ASCII sort, first LEI/pre-LEI
Debt Option	All	Option Buyer
Exotic	All	Reverse ASCII sort, first LEI/pre-LEI
FRA	All	Fixed Rate Payer
IRS Basis	All	Reverse ASCII sort, first LEI/pre-LEI
IRS Fix-Fix	All	Reverse ASCII sort, first LEI/pre-LEI
IRS Fix-Float	All	Fixed Rate Payer
IRSwap: Inflation	When a single Fixed Rate Payer exists	Fixed Rate Payer. Otherwise Reverse ASCII sort, first LEI/pre-LEI
IRSwap: OIS	All	Fixed Rate Payer
Swaption	All	Option Buyer
XCCY Basis	All	Reverse ASCII Sort, first LEI/ pre-LEI
XCCY Fix-Fix	All	Reverse ASCII sort, first LEI/ pre-LEI
XCCY Fix-Float	All	Fixed Rate Payer

Tiebreaker Logic

When the LEI/pre-LEI tiebreaker is invoked the following processes will be used:

1. Identifier Tiebreaker Logic Scenarios
 - i. When only one firm has an LEI/pre-LEI then the party with the LEI/pre-LEI is the RP.
 - ii. When both firms have an LEI/pre-LEI then determine based on comparison of the two LEI/pre-LEIs in accordance with the below.

2. Determining sort order of identifiers

- LEI/pre-LEI are comprised of characters from the following set {0-9, A-Z}.
- For avoidance of doubt, before comparing IDs convert all IDs to UPPER CASE only.
- For comparison basis the sort order will be reverse ASCII sort order. For avoidance of doubt the following are sort order of precedence:
 - Z, Y, X, W, V, U, T, S, R, Q, P, O, N, M, L, K, J, I, H, G, F, E, D, C, B, A, 9, 8, 7, 6, 5, 4, 3, 2, 1, 0.

3. When comparing two IDs the RP will be the firm with the first ID in the list when sorted in reverse ASCII sort order.

Credit

When asset class tie-breaker logic needs to be applied, the UTI generating party is the Floating Rate Payer (a/k/a ‘Seller’). For Swaptions, the UTI generating party is the Floating Rate Payer of the underlying Swap.

For novated transactions, the UTI Generating Party should be reassessed between the Transferee and Remaining Party based on the above.

Commodities

A seller convention applies if the executed trade is one of the three trade types enumerated in the table below. Otherwise, the LEIs of the parties should be compared in standard ASCII order and the party with the first ID in the list will be the UTI generating party.

RP Tiebreaker Logic - Commodities		
Trade Type	Explanation	Reporting Party
Fixed Floating Swap	Seller of the Fixed leg = Reporting Party	Fixed leg seller (Receiver of Cash on the fixed leg)
Option	Receiver of premium payment or Option writer	Seller
Swaption	Receiver of premium payment or Swaption writer	Seller
Option Strategies (Collars, Corridors, Multi-leg)	Premium receiver is the Seller = Reporting Party	Premium Receiver
	If no premium, go to alpha convention	Go to alpha convention
For trade types not listed above		
Seller convention with Alpha	Any trade that falls outside of that list will have the alphanumeric ASCII convention applied based on the LEI/CICI. The LEI/CICI selected as the RP will be the LEI/CICI at the top of that sort order. As an example, ASCII is the same sort logic that MS Excel applies.	

Equities

The UTI Generating Party will be the:

- Seller of performance on any product in the taxonomy⁶.
- Seller of product on all other (exotic) products in the taxonomy.
- If seller cannot be identified the fall back would be for the parties to agree amongst themselves.

For Portfolio Swaps Agreements (PSA's) the seller will remain the seller regardless of the underlier's performance.

For the avoidance of doubt, if the trade is confirmed via negative affirmation, the provider of the negative affirmation agreement is the UTI Generating Party.

FX⁷

When asset class tie-breaker logic needs to be applied:

- For Cash trades: The UTI Generating Party is the counterparty selling the currency that occurs first in the 26-letter English alphabet.
- For Options: The UTI Generating Party is the seller of the option.

RP Tie Breaker Logic - FX		
Taxonomy	Rule	Comment
Forward	FX Cash Rule	For FX Swaps, the UTI Generating Party of both legs of the swap would be determined by applying the Cash Rule to the far-leg of the Swap
NDF	FX Cash Rule	n/a
Option	Option Seller Rule	n/a
NDO	Option Seller Rule	n/a
Simple Exotic	Option Seller Rule	n/a
Complex Exotic	See comment	For a complex exotic product where there is an unambiguous seller of the product, then Option Seller Rule would apply. The seller determination would be driven by the seller as agreed in the standard FpML representation of the product. IF there is no clear seller, then the FX Cash Rule would apply.

¹⁰ <http://www2.isda.org/otc-taxonomies-and-upi/>

¹¹ [http://www.gfma.org/Initiatives/Foreign-Exchange-\(FX\)/FX-Market-Architecture/](http://www.gfma.org/Initiatives/Foreign-Exchange-(FX)/FX-Market-Architecture/)

8 Glossary

8.1 Acronyms used

CCP	Central Counterparty Clearing House
CM	Clearing Member
ED	Executing Dealer
EMIR	European Market Infrastructures Regulation – EU Regulation 648/2012 of the European Parliament and Council on OTC derivatives, central counterparties, and trade repositories.
EOD	End of Day
ESMA	European Markets and Securities Authority
ETD	Exchange Traded Derivatives
FOA	Futures and Options Association
FX	Foreign Exchange
GP	Generating Party (UTI generator)
MSP	Major Swap Participants
OTC	Over-the-Counter [Derivatives]
PB	Prime Broker
RTS	Regulatory Technical Standards adopted by the EC
RP or RCP	Reporting Party; Reporting Counterparty
SD	Swap Dealer
TR	Trade Repository
USI	Unique Swap Identifier
UTI	Unique Transaction Identifier